

# P3CD05065D

650V/5A SiC Power Schottky Barrier Diode Product



**POWERCUBESEMI, INC.**

Potential · Convergence · Smart

## Features

- Positive temperature coefficient for easy parallel use
- Switching characteristics that are not affected by temperature
- Maximum operating temperature 175 °C
- Zero reverse recovery current
- Zero forward recovery voltage

Key Characteristics		
$V_{RRM}$	650	V
$I_F, T_C \leq 160^\circ\text{C}$	5	A
$Q_C$	23	nC

## Benefits

- Unipolar device
- Greatly reduce switching losses
- No thermal crash in parallel devices
- Reduce system dependence on heat sinks

## Applications

- Switch Mode Power Supply (SMPS), Power Factor Correction (PFC)
- Motor drive, photovoltaic inverter, uninterruptible power supply, Wind turbines, train traction systems, electric vehicles.

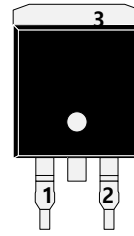

PKG : TO-263

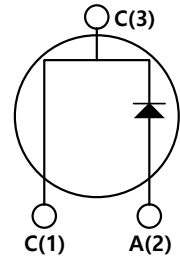

## Absolute Maximum Ratings $T_C = 25^\circ\text{C}$ unless otherwise specified

Symbol	Parameter	Test Condition	Value	Unit
$V_{RRM}$	Repetitive Peak Reverse Voltage		650	V
$V_{RSM}$	Surge Peak Reverse Voltage		650	V
$V_{DC}$	DC Blocking Voltage		650	V
$I_F$	Continuous Forward Current	$T_C=25^\circ\text{C}$	21.5	A
		$T_C=135^\circ\text{C}$	10	A
		$T_C=160^\circ\text{C}$	5	A
$I_{FRM}$	Repetitive Peak Forward Surge Current	$T_C=25^\circ\text{C}$ , $t_p=10\text{ms}$ , Half Sine Wave, $D=0.3$	25	A
$I_{FSM}$	Non-repetitive Peak Forward Surge Current	$T_C=25^\circ\text{C}$ , $t_p=10\text{ms}$ , Half Sine Wave	78	A
$P_{TOT}$	Power Dissipation	$T_C=25^\circ\text{C}$	85.8	W
		$T_C=110^\circ\text{C}$	37.2	
$T_j$	Operating Junction		-55 to 175	$^\circ\text{C}$
$T_{stg}$	Storage Temperature		-55 to 175	$^\circ\text{C}$



**Thermal Characteristics**

Symbol	Parameter	Test Condition	Value	Unit
			Typ.	
$R_{thJc}$	Thermal resistance from junction to case		1.748	°C/W

**Electrical Characteristics, Nomination temperature Tj=25°C**

Symbol	Parameter	Test Condition	Numerical		Unit
			Typ.	Max.	
$V_F$	Forward Voltage	$I_F=5A, T_j=25^\circ C$	1.35	1.7	V
		$I_F=5A, T_j=175^\circ C$	1.55	2.5	
$I_R$	Reverse Current	$V_R=650V, T_j=25^\circ C$	10	50	$\mu A$
		$V_R=650V, T_j=175^\circ C$	20	100	
$Q_C$	Total capacitive Charge	$V_R=400V, T_j=150^\circ C$ $Q_C = \int_0^{V_R} C(V)dV$	23	-	nC
C	Total Capacitance	$V_R=0V, T_j=25^\circ C, f=1MHZ$	424	434	pF
		$V_R=200V, T_j=25^\circ C, f=1MHZ$	44	45	
		$V_R=400V, T_j=25^\circ C, f=1MHZ$	42.5	43	

## Performance Graphs

1) Forward IV characteristics as a function of  $T_j$

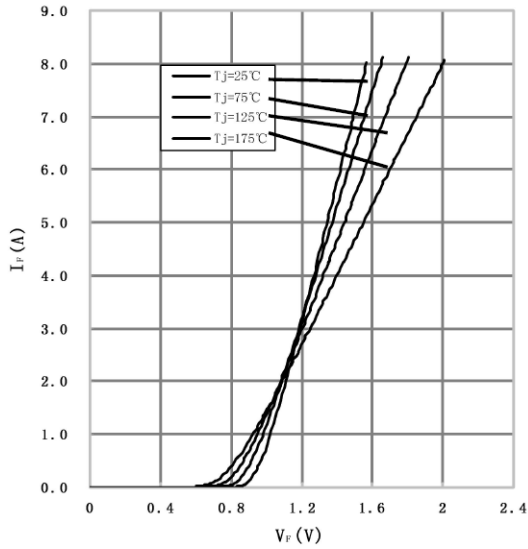

2) Reverse IV characteristics as a function of  $T_j$

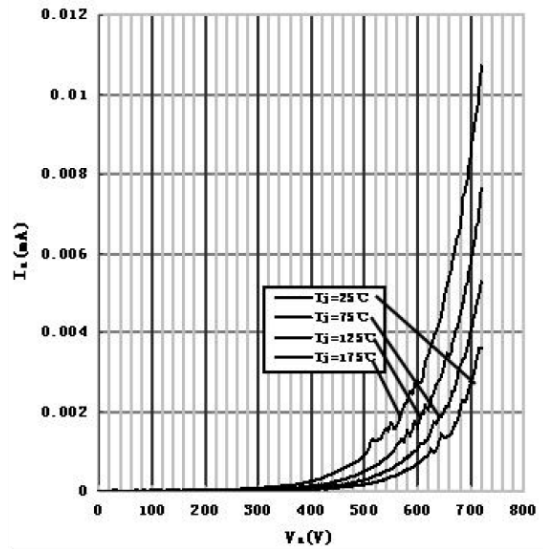

3) Current Derating

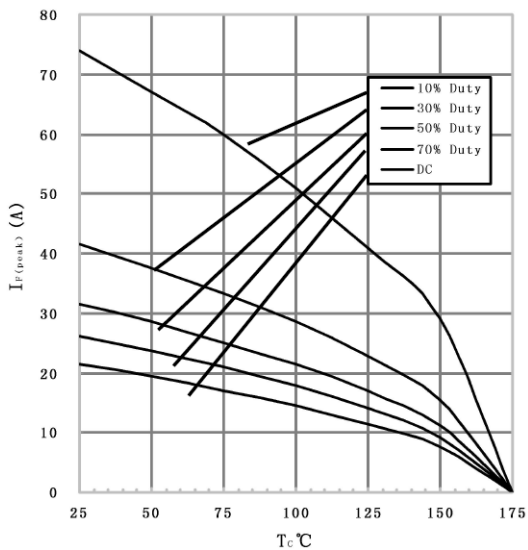

4) Capacitance VS. reverse voltage

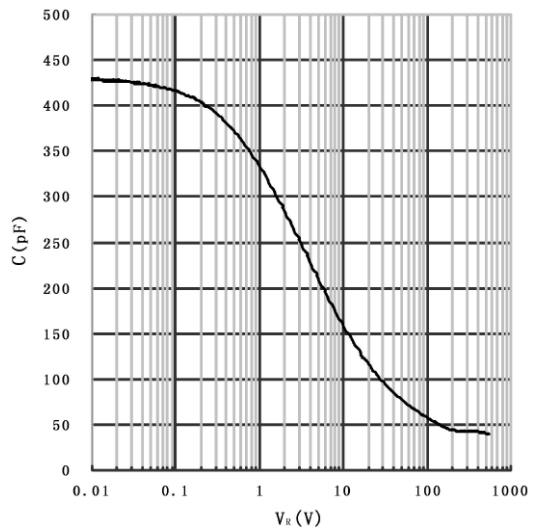

## Package Outline

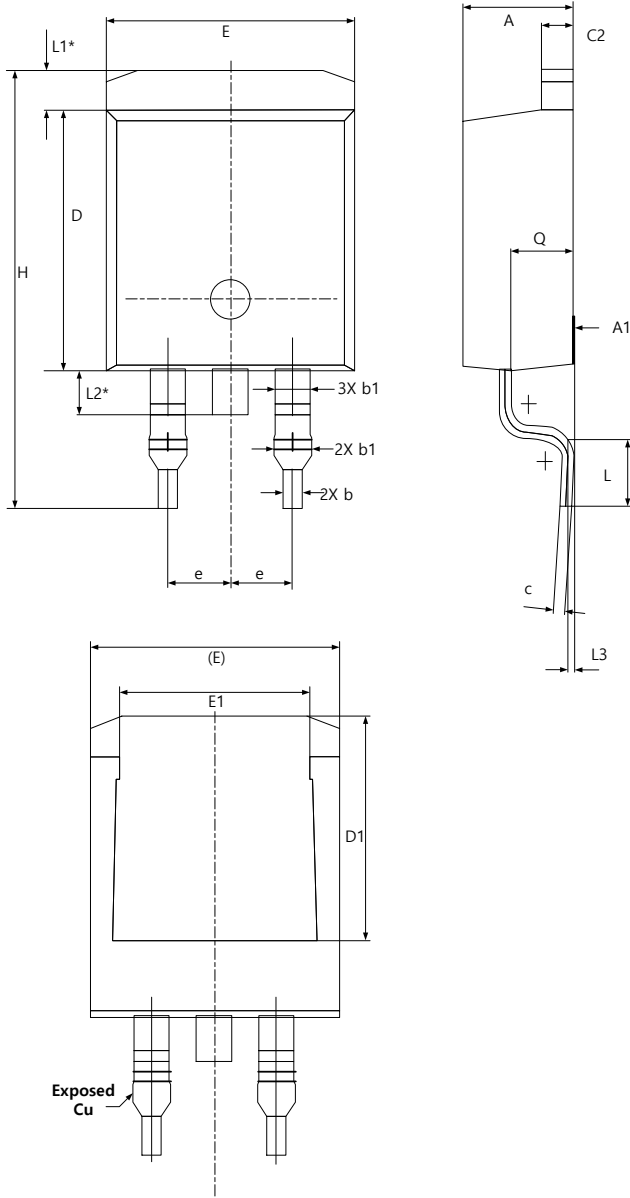

SYMBOL	DIMENSIONS			NOTES
	MIN	NOM	MAX	
<b>A</b>	4.24	4.44	4.64	
<b>A1</b>	0.00	0.10	0.25	
<b>b</b>	0.70	0.80	0.90	
<b>b1</b>	1.20	1.55	1.75	
<b>b2</b>	1.20	1.45	1.70	
<b>C</b>	0.40	0.50	0.60	
<b>C2</b>	1.15	1.25	1.40	
<b>D</b>	8.82	8.92	9.02	
<b>D1</b>	6.86	7.65	-	
<b>E</b>	9.96	10.16	10.36	
<b>E1</b>	6.89	7.77	7.89	
<b>e</b>	2.54 BSC			
<b>H</b>	14.61	15.00	15.88	
<b>L</b>	1.78	2.32	2.79	
<b>L1</b>	1.36 REF			
<b>L2</b>	1.50 REF			
<b>L3</b>	0.25 BSC			
<b>Q</b>	2.30	2.48	2.70	

Symbol	Parameter	Test Condition	Numerical		Unit
			Typ.	Max.	
$M_d$	Mounting torque	M3 Screw 6-32 Screw	1/8.8	-	Nm/ lbf-in