

P3CD06065D

650V/6A SiC Power Schottky Barrier Diode Product



POWERCUBESEMI, INC.

Potential · Convergence · Smart

Features

- Positive temperature coefficient for easy parallel use
- Switching characteristics that are not affected by temperature
- Maximum operating temperature 175 °C
- Zero reverse recovery current
- Zero forward recovery voltage

Key Characteristics		
V_{RRM}	650	V
$I_F, T_C \leq 155^\circ\text{C}$	6	A
Q_C	23	nC

Benefits

- Unipolar device
- Greatly reduce switching losses
- No thermal crash in parallel devices
- Reduce system dependence on heat sinks

Applications

- Switch Mode Power Supply (SMPS), Power Factor Correction (PFC)
- Motor drive, photovoltaic inverter, uninterruptible power supply, Wind turbines, train traction systems, electric vehicles.

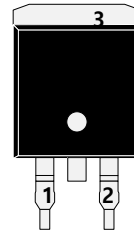

PKG : TO-263

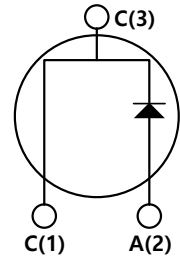

Absolute Maximum Ratings $T_C = 25^\circ\text{C}$ unless otherwise specified

Symbol	Parameter	Test Condition	Value	Unit
V_{RRM}	Repetitive Peak Reverse Voltage		650	V
V_{RSM}	Surge Peak Reverse Voltage		650	V
V_{DC}	DC Blocking Voltage		650	V
I_F	Continuous Forward Current	$T_C=25^\circ\text{C}$	21.5	A
		$T_C=135^\circ\text{C}$	10	A
		$T_C=155^\circ\text{C}$	6	A
I_{FRM}	Repetitive Peak Forward Surge Current	$T_C=25^\circ\text{C}$, $t_p=10\text{ms}$, Half Sine Wave, $D=0.3$	25	A
I_{FSM}	Non-repetitive Peak Forward Surge Current	$T_C=25^\circ\text{C}$, $t_p=10\text{ms}$, Half Sine Wave	78	A
P_{TOT}	Power Dissipation	$T_C=25^\circ\text{C}$	85.8	W
		$T_C=110^\circ\text{C}$	37.2	
T_j	Operating Junction		-55 to 175	$^\circ\text{C}$
T_{stg}	Storage Temperature		-55 to 175	$^\circ\text{C}$



Thermal Characteristics

Symbol	Parameter	Test Condition	Value	Unit
			Typ.	
R_{thJc}	Thermal resistance from junction to case		1.748	°C/W

Electrical Characteristics

Symbol	Parameter	Test Condition	Numerical		Unit
			Typ.	Max.	
V_F	Forward Voltage	$I_F=6A, T_j=25^\circ C$	1.4	1.7	V
		$I_F=6A, T_j=175^\circ C$	1.6	2.5	
I_R	Reverse Current	$V_R=650V, T_j=25^\circ C$	10	50	μA
		$V_R=650V, T_j=175^\circ C$	20	100	
Q_C	Total capacitive Charge	$V_R=400V, T_j=150^\circ C$ $Q_C = \int_0^{V_R} C(V) dV$	23	-	nC
C	Total Capacitance	$V_R=0V, T_j=25^\circ C, f=1MHZ$	424	434	pF
		$V_R=200V, T_j=25^\circ C, f=1MHZ$	44	45	
		$V_R=400V, T_j=25^\circ C, f=1MHZ$	42.5	43	

Performance Graphs

1) Forward IV characteristics as a function of T_j

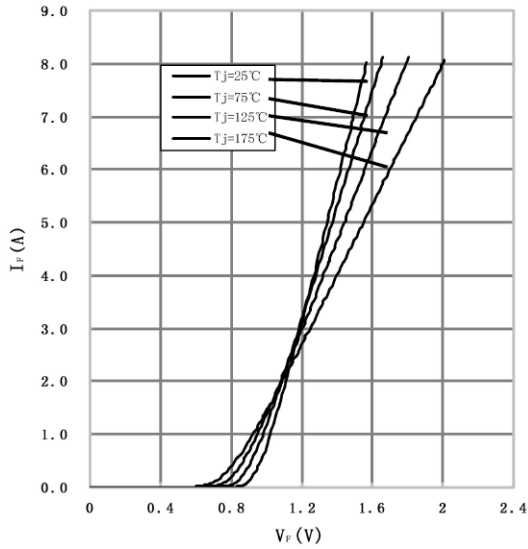

2) Reverse IV characteristics as a function of T_j

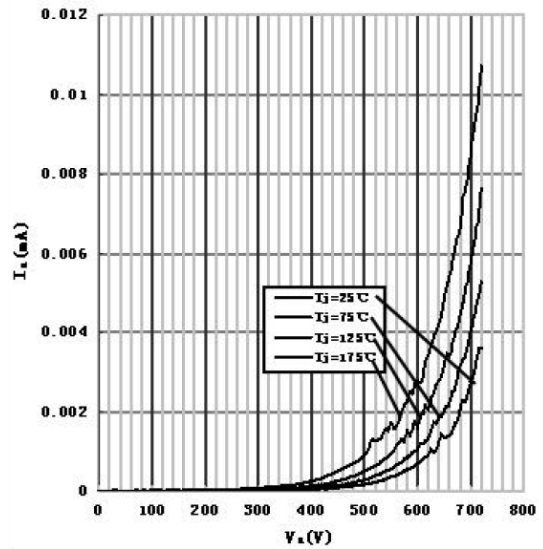

3) Current Derating

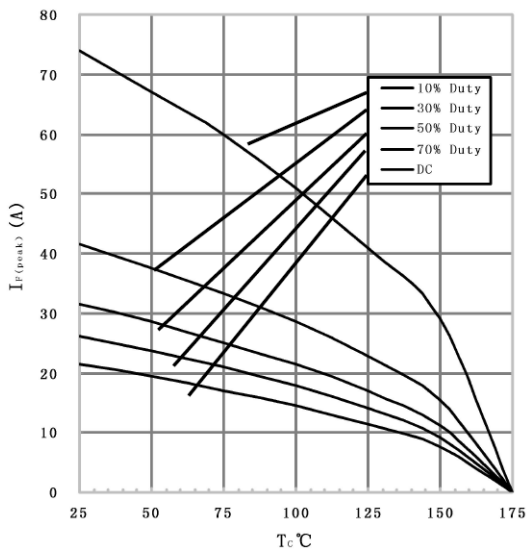

4) Capacitance VS. reverse voltage

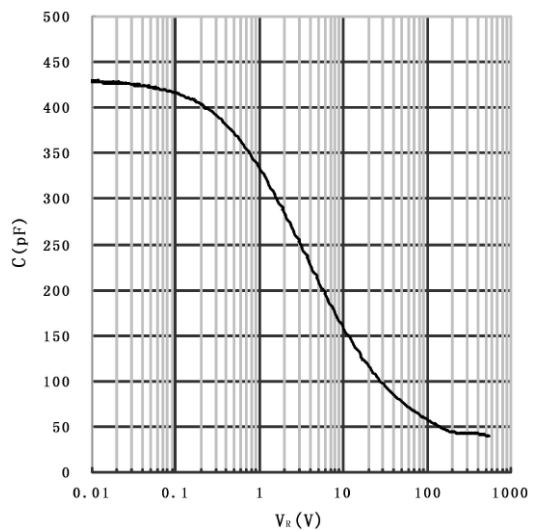

Package Outline

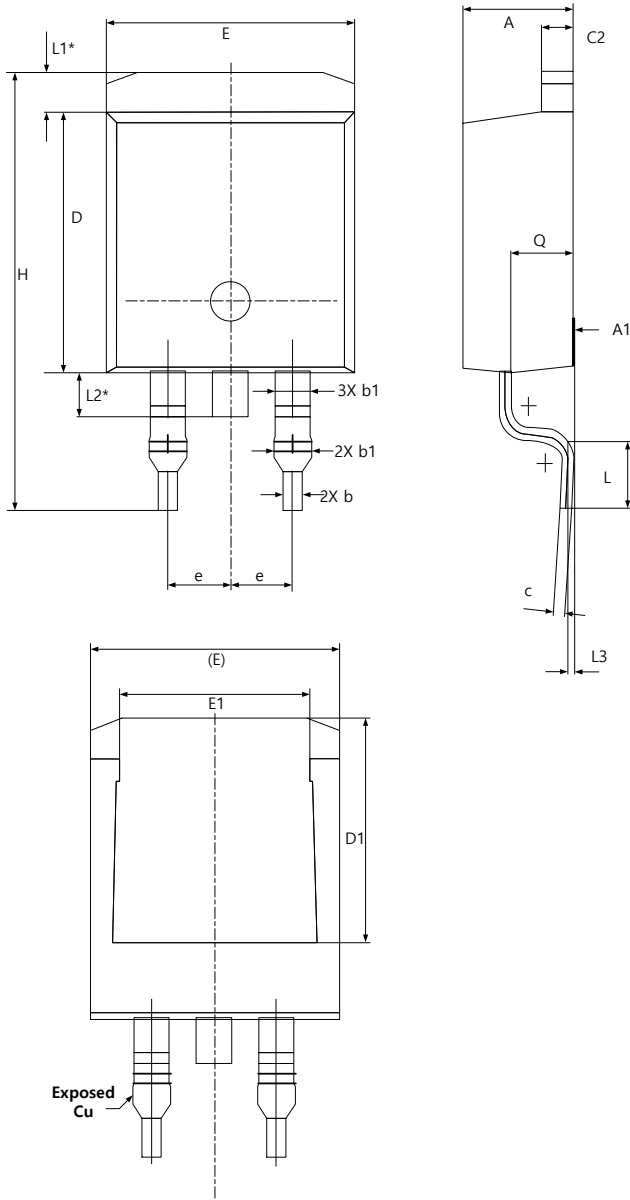

SYMBOL	DIMENSIONS			NOTES
	MIN	NOM	MAX	
A	4.24	4.44	4.64	
A1	0.00	0.10	0.25	
b	0.70	0.80	0.90	
b1	1.20	1.55	1.75	
b2	1.20	1.45	1.70	
C	0.40	0.50	0.60	
C2	1.15	1.25	1.40	
D	8.82	8.92	9.02	
D1	6.86	7.65	-	
E	9.96	10.16	10.36	
E1	6.89	7.77	7.89	
e	2.54 BSC			
H	14.61	15.00	15.88	
L	1.78	2.32	2.79	
L1	1.36 REF			
L2	1.50 REF			
L3	0.25 BSC			
Q	2.30	2.48	2.70	

Symbol	Parameter	Test Condition	Numerical		Unit
			Typ.	Max.	
M_d	Mounting torque	M3 Screw 6-32 Screw	1/8.8	-	Nm/ lbf-in