

# P3CD10065M

650V/10A SiC Power Schottky Barrier Diode Product



**POWERCUBESEMI, INC.**

Potential · Convergence · Smart

## Features

- Positive temperature coefficient for easy parallel use
- Switching characteristics that are not affected by temperature
- Maximum operating temperature 175 °C
- Zero reverse recovery current
- Zero forward recovery voltage

Key Characteristics		
$V_{RRM}$	650	V
$I_F, T_C=120^\circ\text{C}$	11	A
$Q_C$	36	nC

## Benefits

- Unipolar device
- Greatly reduce switching losses
- No thermal crash in parallel devices
- Reduce system dependence on heat sinks

## Applications

- Switch Mode Power Supply (SMPS), Power Factor Correction (PFC)
- Motor drive, photovoltaic inverter, uninterruptible power supply, Wind turbines, train traction systems, electric vehicles.

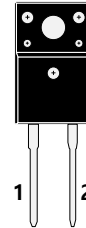

PKG : TO-220F

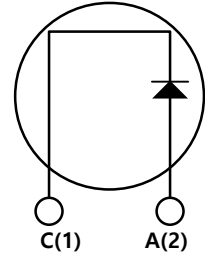

**Absolute Maximum Ratings**  $T_C = 25^\circ\text{C}$  unless otherwise specified

Symbol	Parameter	Test Condition	Value	Unit
$V_{RRM}$	Repetitive Peak Reverse Voltage		650	V
$V_{RSM}$	Surge Peak Reverse Voltage		650	V
$V_{DC}$	DC Blocking Voltage		650	V
$I_F$	Continuous Forward Current	$T_C=25^\circ\text{C}$	18.5	A
		$T_C=100^\circ\text{C}$	13	A
		$T_C=120^\circ\text{C}$	11	A
$I_{FRM}$	Repetitive Peak Forward Surge Current	$T_C=25^\circ\text{C}$ , $t_p=10\text{ms}$ , Half Sine Wave, $D=0.3$	50	A
$I_{FSM}$	Non-repetitive Peak Forward Surge Current	$T_C=25^\circ\text{C}$ , $t_p=10\text{ms}$ , Half Sine Wave	120	A
$P_{TOT}$	Power Dissipation	$T_C=25^\circ\text{C}$	52.1	W
		$T_C=110^\circ\text{C}$	23	
$T_j$	Operating Junction		-55 to 175	$^\circ\text{C}$
$T_{stg}$	Storage Temperature		-55 to 175	$^\circ\text{C}$



### Thermal Characteristics

Symbol	Parameter	Test Condition	Value	Unit
			Typ.	
$R_{thJc}$	Thermal resistance from junction to case		2.877	°C/W

### Electrical Characteristics

Symbol	Parameter	Test Condition	Numerical		Unit
			Typ.	Max.	
$V_F$	Forward Voltage	$I_F=10A, T_j=25^{\circ}C$	1.42	1.7	V
		$I_F=10A, T_j=175^{\circ}C$	1.7	2.5	
$I_R$	Reverse Current	$V_R=650V, T_j=25^{\circ}C$	10	50	$\mu A$
		$V_R=650V, T_j=175^{\circ}C$	20	100	
$Q_C$	Total capacitive Charge	$V_R=400V, T_j=150^{\circ}C$ $Q_C = \int_0^{V_R} C(V)dV$	36	-	nC
C	Total Capacitance	$V_R=0V, T_j=25^{\circ}C, f=1MHZ$	690	730	pF
		$V_R=200V, T_j=25^{\circ}C, f=1MHZ$	72	75	
		$V_R=400V, T_j=25^{\circ}C, f=1MHZ$	71	74	

## Performance Graphs

1) Forward IV characteristics as a function of  $T_j$

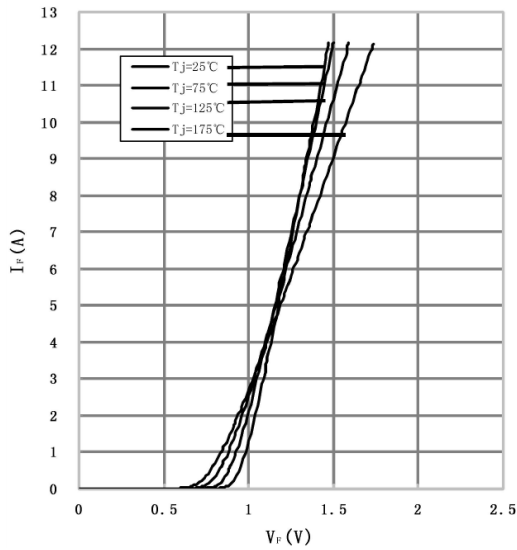

2) Reverse IV characteristics as a function of  $T_j$

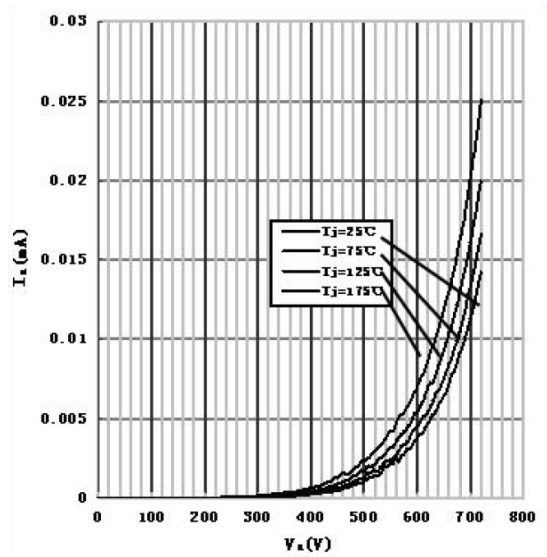

3) Current Derating

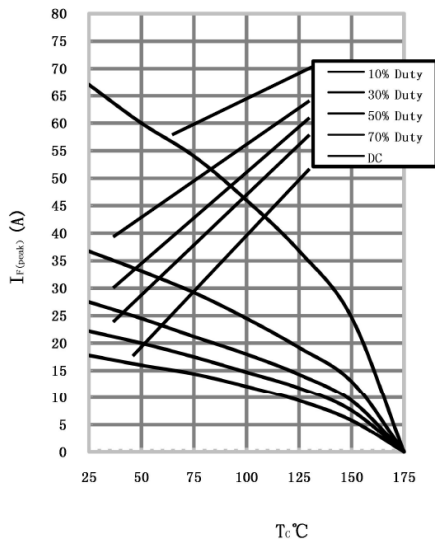

4) Capacitance VS. reverse voltage

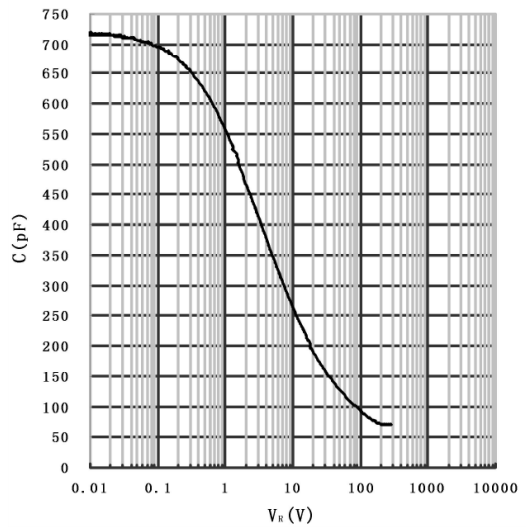

## Package Outline

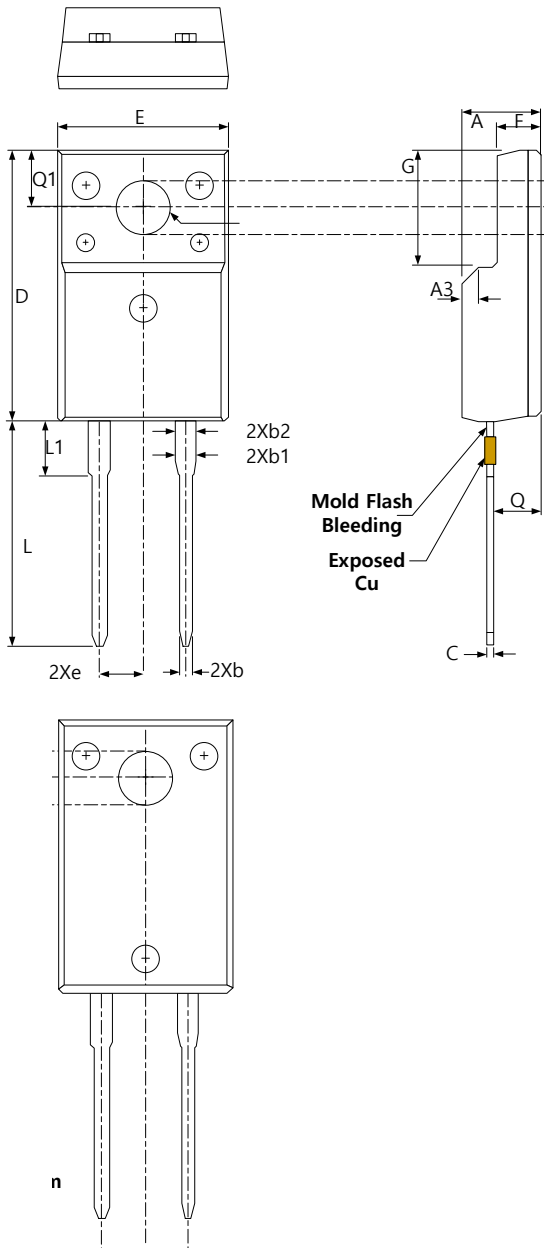

SYMBOL	DIMENSIONS			NOTES
	MIN	NOM	MAX	
<b>A</b>	4.60	4.70	4.80	
<b>b</b>	0.70	0.80	0.91	
<b>b1</b>	1.20	1.30	1.47	
<b>b2</b>	1.10	1.20	1.30	
<b>C</b>	0.45	0.50	0.63	
<b>D</b>	15.80	15.87	15.97	
<b>e</b>	2.54			
<b>E</b>	10.00	10.10	10.30	
<b>F</b>	2.44	2.54	2.64	
<b>G</b>	6.50	6.70	6.90	
<b>L</b>	12.90	13.10	13.30	
<b>L1</b>	3.13	3.23	3.33	
<b>Q</b>	2.65	2.75	2.85	
<b>Q1</b>	3.20	3.30	3.40	
<b>φR</b>	3.08	3.18	3.28	

Symbol	Parameter	Test Condition	Numerical		Unit
			Typ.	Max.	
M <sub>d</sub>	Mounting torque	M3 Screw 6-32 Screw	1/8.8	-	Nm/ lbf-in