

P3CD40120B

1200V/40A SiC Power Schottky Barrier Diode Product



POWERCUBESEMI, INC.

Potential · Convergence · Smart

Features

- Positive temperature coefficient for easy parallel use
- Switching characteristics that are not affected by temperature
- Maximum operating temperature 175 °C
- Zero reverse recovery current
- Zero forward recovery voltage

Benefits

- Unipolar device
- Greatly reduce switching losses
- No thermal crash in parallel devices
- Reduce system dependence on heat sinks

Applications

- Switch Mode Power Supply (SMPS), Power Factor Correction (PFC)
- Motor drive, photovoltaic inverter, uninterruptible power supply, Wind turbines, train traction systems, electric vehicles.

| Key Characteristics | | |
|-----------------------------------|------|----|
| V_{RRM} | 1200 | V |
| $I_F, T_C \leq 140^\circ\text{C}$ | 20* | A |
| Q_C | 161* | nC |

* : per Leg

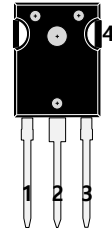

PKG : TO-247

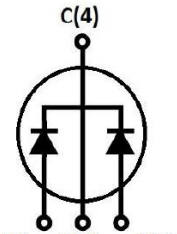

A(1) C(2) A(3)



Absolute Maximum Ratings $T_C = 25^\circ\text{C}$ unless otherwise specified

| Symbol | Parameter | Test Condition | Value | Unit |
|-----------|---|--|------------|------------------|
| V_{RRM} | Repetitive Peak Reverse Voltage | | 1200 | V |
| V_{RSM} | Surge Peak Reverse Voltage | | 1200 | V |
| V_{DC} | DC Blocking Voltage | | 1200 | V |
| I_F | Continuous Forward Current | $T_C=25^\circ\text{C}$ | 47* | A |
| | | $T_C=110^\circ\text{C}$ | 30* | A |
| | | $T_C=140^\circ\text{C}$ | 20* | A |
| I_{FRM} | Repetitive Peak Forward Surge Current | $T_C=25^\circ\text{C}$, $t_p=10\text{ms}$, Half Sine Wave, $D=0.3$ | 100* | A |
| I_{FSM} | Non-repetitive Peak Forward Surge Current | $T_C=25^\circ\text{C}$, $t_p=10\text{ms}$, Half Sine Wave | 270* | A |
| P_{TOT} | Power Dissipation | $T_C=25^\circ\text{C}$ | 349* | W |
| | | $T_C=110^\circ\text{C}$ | 151* | |
| T_j | Operating Junction | | -55 to 175 | $^\circ\text{C}$ |
| T_{stg} | Storage Temperature | | -55 to 175 | $^\circ\text{C}$ |



Thermal Characteristics

| Symbol | Parameter | Test Condition | Value | Unit |
|------------|--|----------------|-----------------|------|
| | | | Typ. | |
| R_{thJc} | Thermal resistance from junction to case | | 0.43* 0.21** | °C/W |

Electrical Characteristics, Nomination temperature $T_j=25^{\circ}\text{C}$

| Symbol | Parameter | Test Condition | Numerical | | Unit |
|--------|-------------------------|---|-----------|------|---------------|
| | | | Typ. | Max. | |
| V_F | Forward Voltage | $I_F=20\text{A}, T_j=25^{\circ}\text{C}$ | 1.45 | 1.7 | V |
| | | $I_F=20\text{A}, T_j=175^{\circ}\text{C}$ | 2.26 | 2.5 | |
| I_R | Reverse Current | $V_R=1200\text{V}, T_j=25^{\circ}\text{C}$ | 15 | 50 | μA |
| | | $V_R=1200\text{V}, T_j=175^{\circ}\text{C}$ | 25 | 100 | |
| Q_C | Total capacitive Charge | $V_R=800\text{V}, T_j=150^{\circ}\text{C}$ $Q_C = \int_0^{V_R} C(V)dV$ | 161 | - | nC |
| C | Total Capacitance | $V_R=0\text{V}, T_j=25^{\circ}\text{C}, f=1\text{MHZ}$ | 2600 | 2700 | pF |
| | | $V_R=400\text{V}, T_j=25^{\circ}\text{C}, f=1\text{MHZ}$ | 140 | 145 | |
| | | $V_R=800\text{V}, T_j=25^{\circ}\text{C}, f=1\text{MHZ}$ | 137 | 140 | |

Performance Graphs

1) Forward IV characteristics as a function of T_j

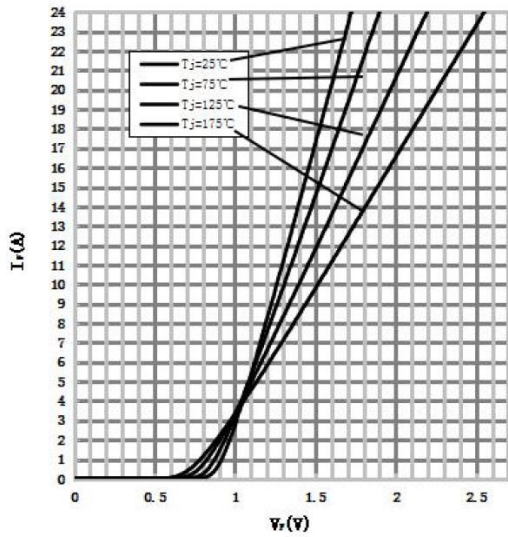

2) Reverse IV characteristics as a function of T_j

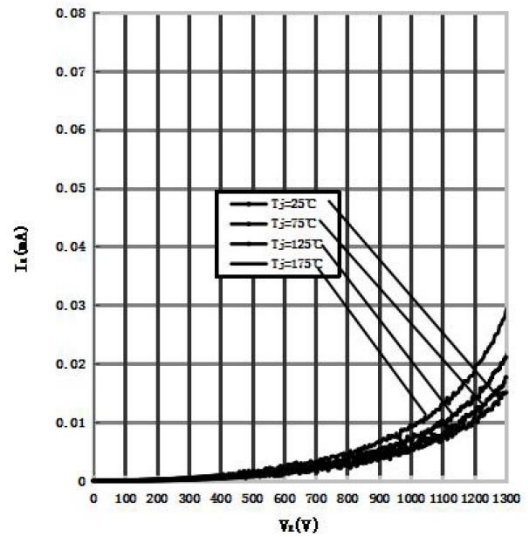

3) Current Derating

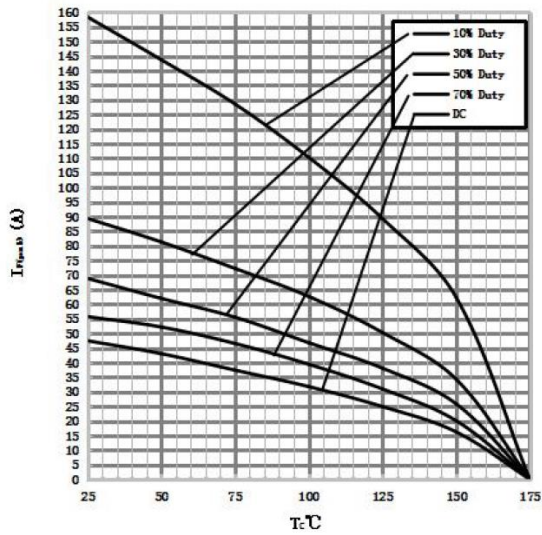

4) Capacitance VS. reverse voltage

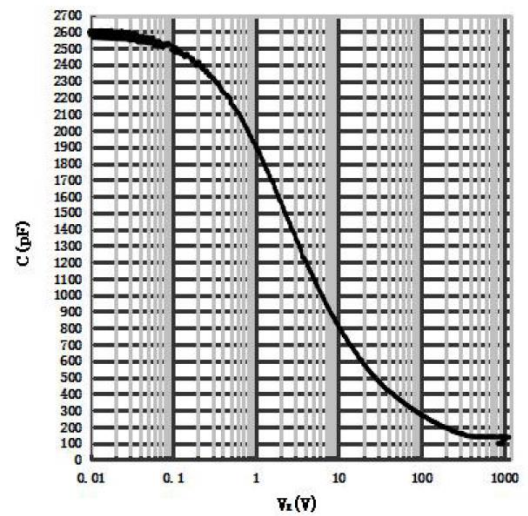

Package Outline

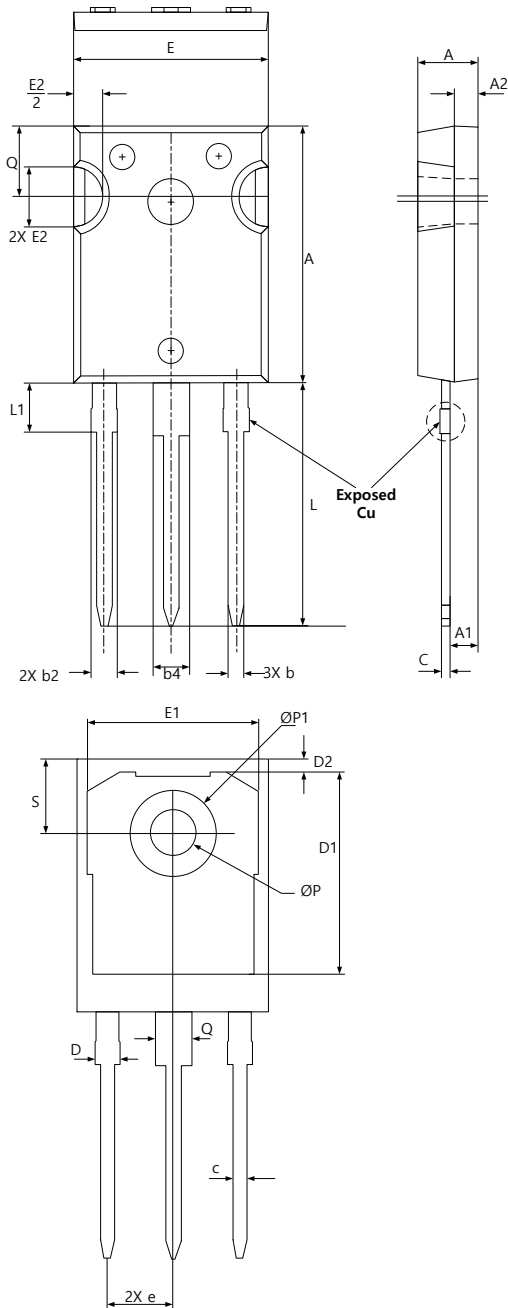

| SYMBOL | DIMENSIONS | | | NOTES |
|-----------------------------|------------|-------|-------|-------|
| | MIN | NOM | MAX | |
| A | 4.83 | 5.02 | 5.21 | |
| A1 | 2.29 | 2.41 | 2.55 | |
| A2 | 1.50 | 2.00 | 2.49 | |
| b | 1.12 | 1.20 | 1.33 | |
| b1 | 1.12 | 1.20 | 1.28 | |
| b2 | 1.91 | 2.00 | 2.39 | 6 |
| b3 | 1.91 | 2.00 | 2.34 | |
| b4 | 2.87 | 3.00 | 3.22 | 6, 8 |
| b5 | 2.87 | 3.00 | 3.18 | |
| c | 0.55 | 0.60 | 0.69 | 6 |
| c1 | 0.55 | 6.00 | 0.65 | |
| D | 20.80 | 20.95 | 21.10 | 4 |
| D1 | 16.25 | 16.55 | 17.65 | 5 |
| D2 | 0.51 | 1.19 | 1.35 | |
| E | 15.75 | 15.94 | 16.13 | 4 |
| E1 | 13.46 | 14.02 | 14.16 | 5 |
| E2 | 4.32 | 4.91 | 5.49 | 3 |
| e | 5.44 BSC | | | |
| L | 19.81 | 20.07 | 20.32 | |
| L1 | 4.10 | 4.19 | 4.40 | 6 |
| ϕP | 3.56 | 3.61 | 3.65 | 7 |
| $\phi P1$ | 7.19 REF | | | |
| Q | 5.39 | 5.79 | 6.20 | |
| S | 6.04 | 6.17 | 6.30 | |

| Symbol | Parameter | Test Condition | Numerical | | Unit |
|--------|-----------------|------------------------|-----------|------|----------------|
| | | | Typ. | Max. | |
| M_d | Mounting torque | M3 Screw 6-32 Screw | 1/8.8 | - | Nm/ lbf.in. |