

P3CD60065B

650V/60A SiC Power Schottky Barrier Diode Product



POWERCUBESEMI, INC.

Potential · Convergence · Smart

Features

- Positive temperature coefficient for easy parallel use
- Switching characteristics that are not affected by temperature
- Maximum operating temperature 175 °C
- Zero reverse recovery current
- Zero forward recovery voltage

Benefits

- Unipolar device
- Greatly reduce switching losses
- No thermal crash in parallel devices
- Reduce system dependence on heat sinks

Applications

- Switch Mode Power Supply (SMPS), Power Factor Correction (PFC)
- Motor drive, photovoltaic inverter, uninterruptible power supply, Wind turbines, train traction systems, electric vehicles.

Key Characteristics		
V_{RRM}	650	V
$I_F, T_C \leq 135^\circ\text{C}$	30*	A
Q_C	101*	nC

* : per Leg

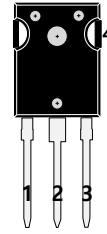

PKG : TO-247

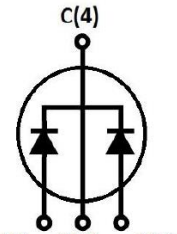

A(1) C(2) A(3)



Absolute Maximum Ratings $T_C = 25^\circ\text{C}$ unless otherwise specified

Symbol	Parameter	Test Condition	Value	Unit
V_{RRM}	Repetitive Peak Reverse Voltage		650	V
V_{RSM}	Surge Peak Reverse Voltage		650	V
V_{DC}	DC Blocking Voltage		650	V
I_F	Continuous Forward Current	$T_C=25^\circ\text{C}$	64*	A
		$T_C=100^\circ\text{C}$	40*	A
		$T_C=135^\circ\text{C}$	30*	A
I_{FRM}	Repetitive Peak Forward Surge Current	$T_C=25^\circ\text{C}$, $t_p=10\text{ms}$, Half Sine Wave, $D=0.3$	150*	A
I_{FSM}	Non-repetitive Peak Forward Surge Current	$T_C=25^\circ\text{C}$, $t_p=10\text{ms}$, Half Sine Wave	300*	A
P_{TOT}	Power Dissipation	$T_C=25^\circ\text{C}$	192.3*	W
		$T_C=110^\circ\text{C}$	83*	
T_j	Operating Junction		-55 to 175	$^\circ\text{C}$
T_{stg}	Storage Temperature		-55 to 175	$^\circ\text{C}$



Thermal Characteristics

Symbol	Parameter	Test Condition	Value	Unit
			Typ.	
R_{thJc}	Thermal resistance from junction to case		0.78* 0.39**	°C/W

Electrical Characteristics

Symbol	Parameter	Test Condition	Numerical		Unit
			Typ.	Max.	
V_F	Forward Voltage	$I_F=30A, T_j=25^\circ C$	1.46	1.7	V
		$I_F=30A, T_j=175^\circ C$	2	2.5	
I_R	Reverse Current	$V_R=650V, T_j=25^\circ C$	10	50	μA
		$V_R=650V, T_j=175^\circ C$	20	100	
Q_C	Total capacitive Charge	$V_R=400V, T_j=150^\circ C$ $Q_C = \int_0^{V_R} C(V)dV$	101	-	nC
C	Total Capacitance	$V_R=0V, T_j=25^\circ C, f=1MHZ$	2150	2300	pF
		$V_R=200V, T_j=25^\circ C, f=1MHZ$	188	191	
		$V_R=400V, T_j=25^\circ C, f=1MHZ$	183	184	

Performance Graphs

1) Forward IV characteristics as a function of T_j

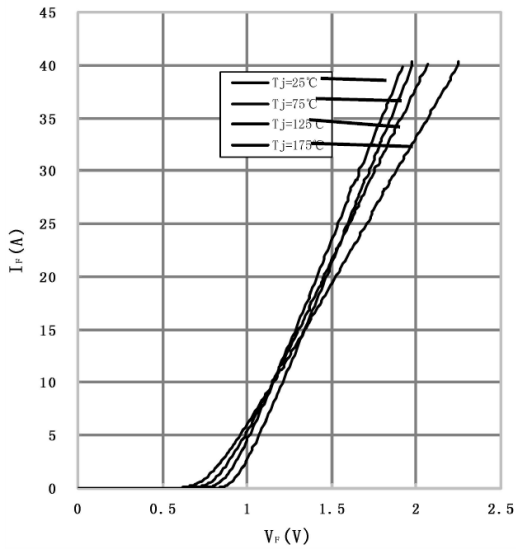

2) Reverse IV characteristics as a function of T_j

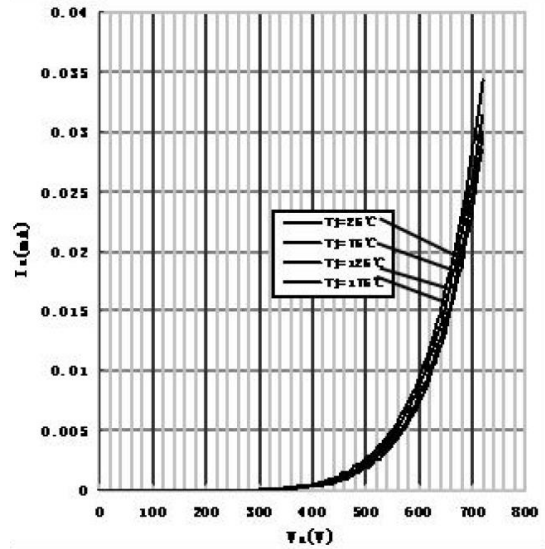

3) Current Derating

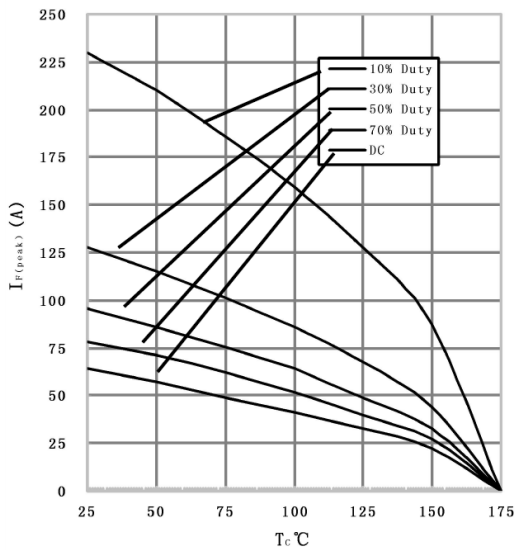

4) Capacitance VS. reverse voltage

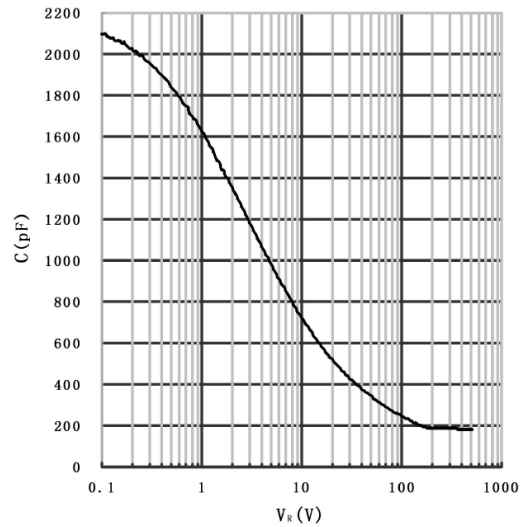

Package Outline

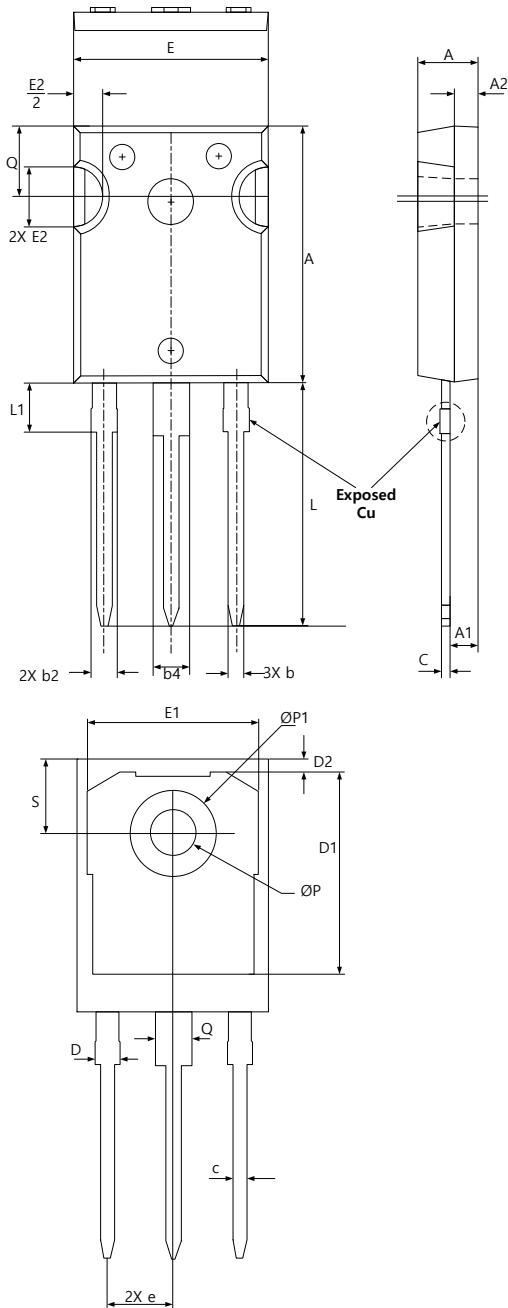

SYMBOL	DIMENSIONS			NOTES
	MIN	NOM	MAX	
A	4.83	5.02	5.21	
A1	2.29	2.41	2.55	
A2	1.50	2.00	2.49	
b	1.12	1.20	1.33	
b1	1.12	1.20	1.28	
b2	1.91	2.00	2.39	6
b3	1.91	2.00	2.34	
b4	2.87	3.00	3.22	6, 8
b5	2.87	3.00	3.18	
c	0.55	0.60	0.69	6
c1	0.55	6.00	0.65	
D	20.80	20.95	21.10	4
D1	16.25	16.55	17.65	5
D2	0.51	1.19	1.35	
E	15.75	15.94	16.13	4
E1	13.46	14.02	14.16	5
E2	4.32	4.91	5.49	3
e	5.44 BSC			
L	19.81	20.07	20.32	
L1	4.10	4.19	4.40	6
ϕP	3.56	3.61	3.65	7
$\phi P1$	7.19 REF			
Q	5.39	5.79	6.20	
S	6.04	6.17	6.30	

Symbol	Parameter	Test Condition	Numerical		Unit
			Typ.	Max.	
M_d	Mounting torque	M3 Screw 6-32 Screw	1/8.8	-	Nm/ lbf.in.