



PCD06065D

650V Silicon Carbide Diode

Features

- 650-Volt Schottky Rectifier
- Shorter recovery time
- High-speed switching possible
- High-Frequency Operation
- Temperature-Independent Switching Behavior
- Extremely Fast Switching
- Positive Temperature Coefficient on VF
- RoHS Compliant
- AEC-Q101 Qualified

Applications

- Switch Mode Power Supplies
- Power Factor Correction
- Motor Drives
- Uninterruptible Power Supply
- Solar Inverter
- EV Charger
- On-Board Charger

Package Outline

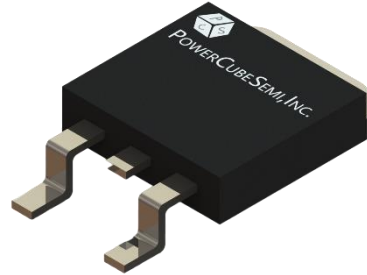

PKG : TO-263

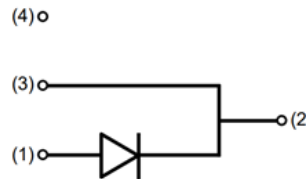

1. Anode
2. Case
3. Cathode
4. No Connection

Absolute Maximum Ratings

$T_C = 25^\circ\text{C}$ unless otherwise noted

Symbol	Parameter	Value	Units
V_{RRM}	Repetitive Peak Reverse Voltage	650	V
V_{RSM}	Surge Peak Reverse Voltage	650	V
V_{DC}	DC Blocking Voltage	650	V
I_F	Continuous Forward Current $T_C = 25^\circ\text{C}$ $T_C = 150^\circ\text{C}$	17 6	A
I_{FRM}	Repetitive Peak Forward Current $T_C = 110^\circ\text{C}$	15	A
I_{FSM}	Non-Repetitive Forward Surge Current (PW=10ms sinusoidal) $T_C = 25^\circ\text{C}$ $T_C = 110^\circ\text{C}$	43 35	A
P_D	Power Dissipation $T_C = 25^\circ\text{C}$	68	W
T_J, T_{stg}	Operating Junction and Storage Temperature	-55 to +175	$^\circ\text{C}$

Electrical Characteristics

$T_C = 25^\circ\text{C}$ unless otherwise noted

Symbol	Parameter	Test Conditions	Min	Typ	Max	Units
V_F	Forward Voltage	$I_F = 15\text{A}, T_C = 25^\circ\text{C}$ $I_F = 15\text{A}, T_C = 175^\circ\text{C}$	- -	1.45 1.95	1.75 2.35	V
I_R	Reverse Current	$V_R = 650\text{V}, T_C = 25^\circ\text{C}$ $V_R = 650\text{V}, T_C = 175^\circ\text{C}$	- -	5 25	100 -	μA
Q_C	Total Capacitive Charge	$V_R = 400\text{V}$	- -	23	- -	nC
C	Total Capacitance	$V_R = 1\text{V}, f = 1\text{MHz}$ $V_R = 520\text{V}, f = 1\text{MHz}$	- -	269 41	- -	pF

Thermal Characteristics

$T_C = 25^\circ\text{C}$ unless otherwise noted

Symbol	Parameter	Min	Typ	Max	Units
$R_{\theta JC}$	Thermal Resistance, Junction-to-Case	-	2.2	2.6	$^\circ\text{C}/\text{W}$

Typical Characteristics

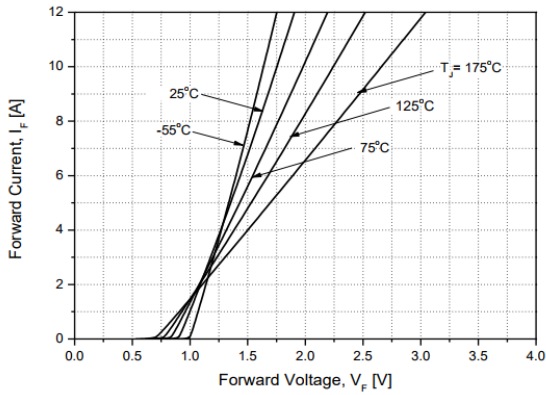

Figure 1. Forward Characteristics

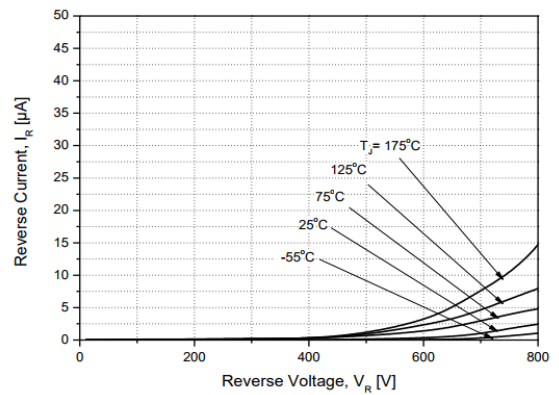

Figure 2. Reverse Characteristics

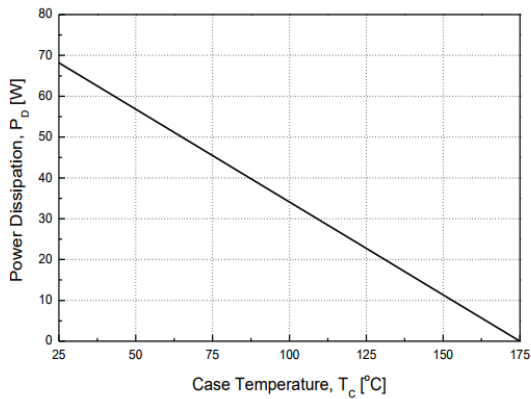

Figure 3. Power Dissipation

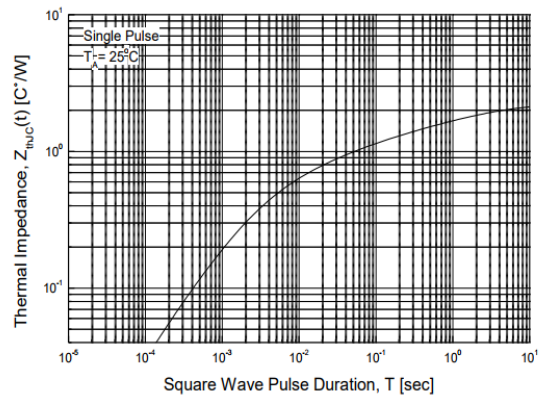

Figure 4. Transient Thermal Resistance

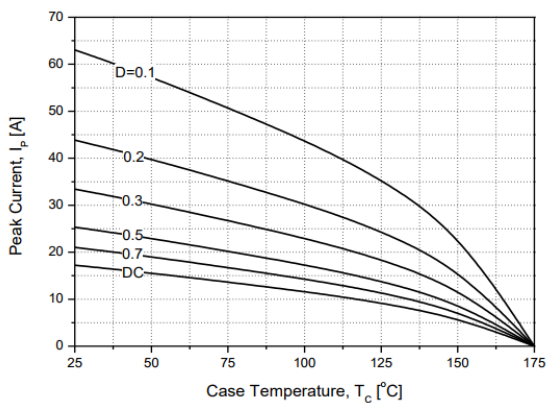

Figure 5. Peak Forward Current Derating

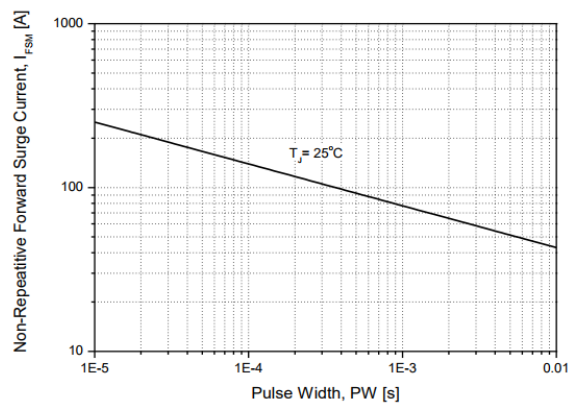

Figure 6. Non-Repetitive Peak Forward Surge Current vs. Pulse Duration

Typical Characteristics

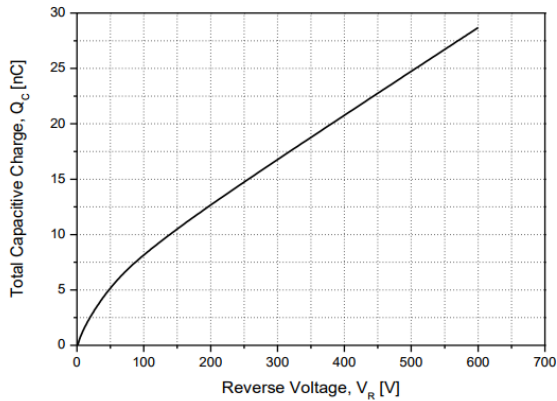

Figure 7. Total Capacitive Charge

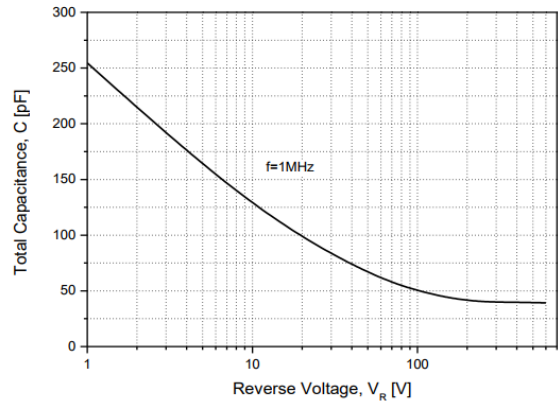

Figure 8. Total Capacitance

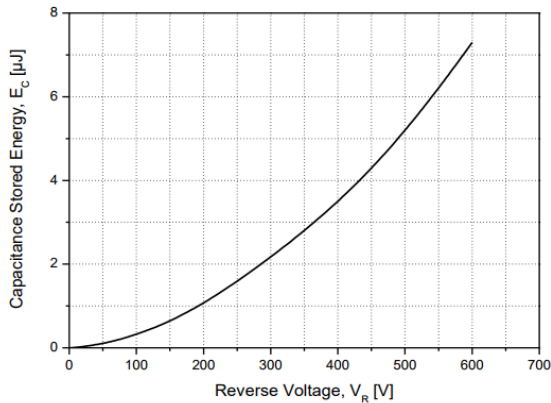

Figure 9. Capacitance Store Energy

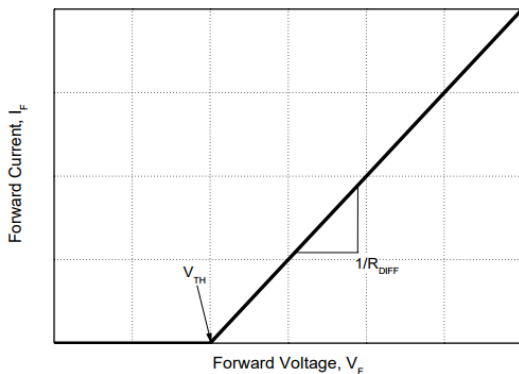

Figure 10. Equivalent Forward Current Curve

$$V_F = V_{TH} + R_{DIFF} \times I_F$$

Threshold Voltage (V_{TH})

$$V_{TH}(T_j) = -0.001 \times (T_j) + 0.950 \text{ [V]}$$

Differential Resistance (R_{DIFF})

$$R_{DIFF}(T_j) = A \times T_j^2 + B \times T_j + C \text{ [\Omega]}$$

$$A = 1.56 \times 10^{-6}$$

$$B = 3.18 \times 10^{-4}$$

$$C = 7.26 \times 10^{-2}$$

$$[T_j \text{ [}^\circ\text{C]}; -55 \text{ }^\circ\text{C} \leq T_j \leq 175 \text{ }^\circ\text{C}; I_F \leq 6 \text{ A}]$$

Package Information

Unit : mm

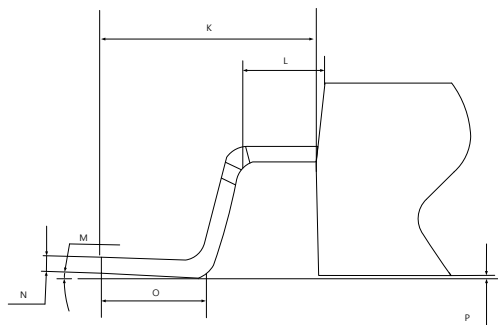
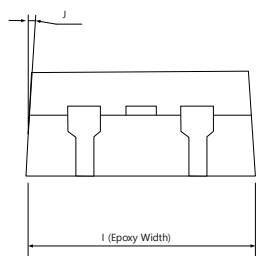
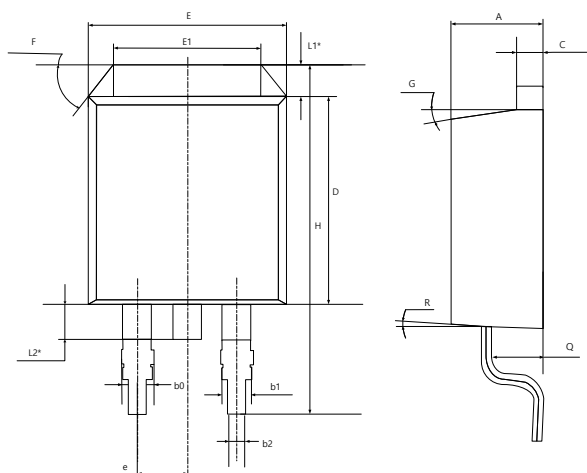

SYMBOL	DIMENSIONS			NOTE
	MIN	NOM	MAX	
A	4.40	4.60	4.80	
b0	1.17	1.37	1.57	
b1	1.17	1.27	1.37	
b2	0.70	0.80	0.90	
C	1.17	1.27	1.37	
D	8.50	8.70	8.90	
E	9.80	10.00	10.20	
E1	6.50	-	-	
e	2.44	2.54	2.64	
F	-	30° (Ref)	-	
G	-	7.0°	-	
H	15.00	15.30	15.60	
I	9.80	10.00	10.20	
J	-	3.0°	-	
K	5.00	5.30	5.60	
L	1.80	2.00	2.20	
L1	1.07	1.27	1.47	
L2	1.20	1.50	1.80	
M	0.0°	-	8.0°	
N	0.30	0.45	0.60	
O	2.34	2.54	2.74	
P	0	-	0.25	
Q	2.37	2.67	2.97	
R	-	7.0°	-	