



PCD15065H

650V Silicon Carbide Diode

Features

- 650-Volt Schottky Rectifier
- Shorter recovery time
- High-speed switching possible
- High-Frequency Operation
- Temperature-Independent Switching Behavior
- Extremely Fast Switching
- Positive Temperature Coefficient on VF
- RoHS Compliant

Applications

- Switch Mode Power Supplies
- Power Factor Correction
- Motor Drives
- Uninterruptible Power Supply
- Solar Inverter
- EV Charger

Package Outline

PKG : TO-220F

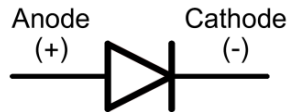
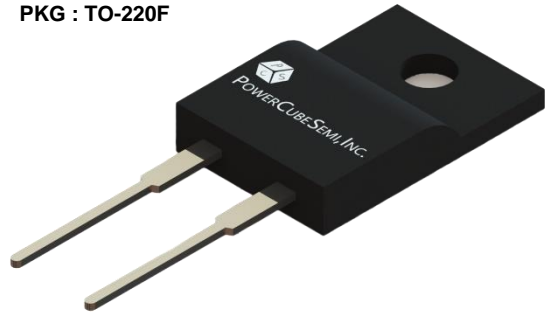

Absolute Maximum Ratings

$T_C = 25^\circ\text{C}$ unless otherwise noted

Symbol	Parameter	Value	Units	
V_{RRM}	Repetitive Peak Reverse Voltage	650	V	
V_{RSM}	Surge Peak Reverse Voltage	650	V	
V_{DC}	DC Blocking Voltage	650	V	
I_F	Continuous Forward Current	$T_C = 25^\circ\text{C}$ $T_C = 90^\circ\text{C}$	21 15	A
I_{FRM}	Repetitive Peak Forward Current	$T_C = 110^\circ\text{C}$	54	A
I_{FSM}	Non-Repetitive Forward Surge Current (PW=10ms sinusoidal)	$T_C = 25^\circ\text{C}$ $T_C = 110^\circ\text{C}$	120 96	A
P_D	Power Dissipation	$T_C = 25^\circ\text{C}$	49	W
T_J, T_{stg}	Operating Junction and Storage Temperature		-55 to +175	$^\circ\text{C}$

Electrical Characteristics

$T_C = 25^\circ\text{C}$ unless otherwise noted

Symbol	Parameter	Test Conditions	Min	Typ	Max	Units
V_F	Forward Voltage	$I_F = 15\text{A}, T_C = 25^\circ\text{C}$ $I_F = 15\text{A}, T_C = 175^\circ\text{C}$	--	1.45 2.0	1.75 2.4	V
I_R	Reverse Current	$V_R = 650\text{V}, T_C = 25^\circ\text{C}$ $V_R = 650\text{V}, T_C = 175^\circ\text{C}$	--	5 25	100 -	μA
Q_C	Total Capacitive Charge	$V_R = 400\text{V}$	--	50	--	nC
C	Total Capacitance	$V_R = 1\text{V}, T_J = 25^\circ\text{C}, f = 1\text{MHz}$ $V_R = 520\text{V}, T_J = 25^\circ\text{C}, f = 1\text{MHz}$	--	674 89	--	pF

Thermal Characteristics

$T_C = 25^\circ\text{C}$ unless otherwise noted

Symbol	Parameter	Min	Typ	Max	Units
$R_{\theta JC}$	Thermal Resistance, Junction-to-Case	--	3.03	3.64	$^\circ\text{C}/\text{W}$

Typical Characteristics

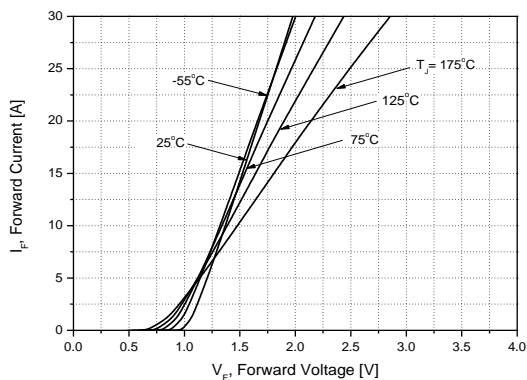

Figure 1. Forward Characteristics

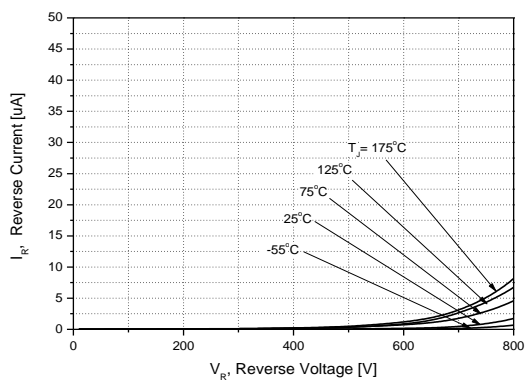

Figure 2. Reverse Characteristics

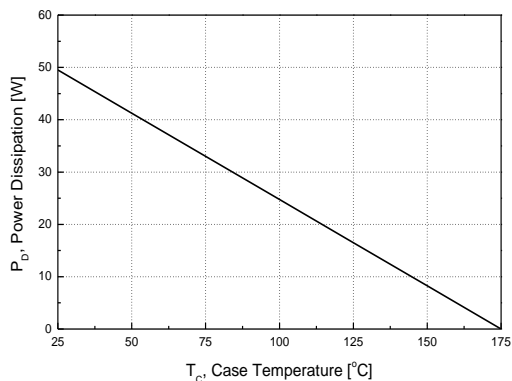

Figure 3. Power Dissipation

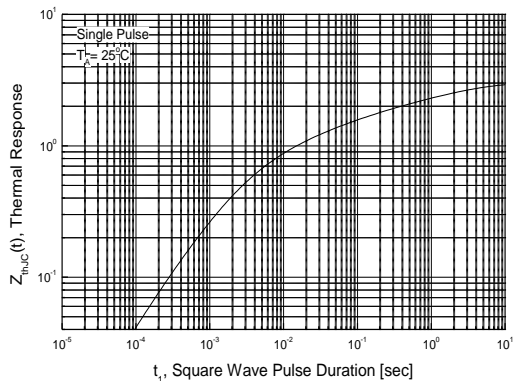

Figure 4. Transient Thermal Resistance

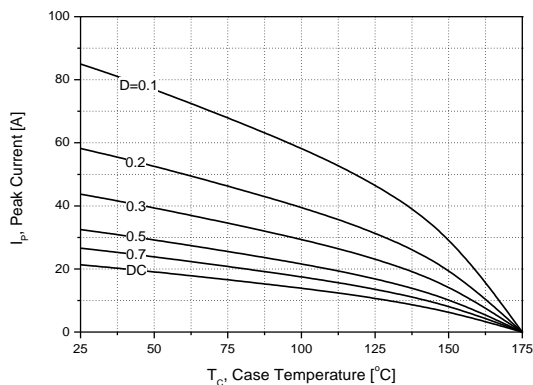

Figure 5. Peak Forward Current Derating

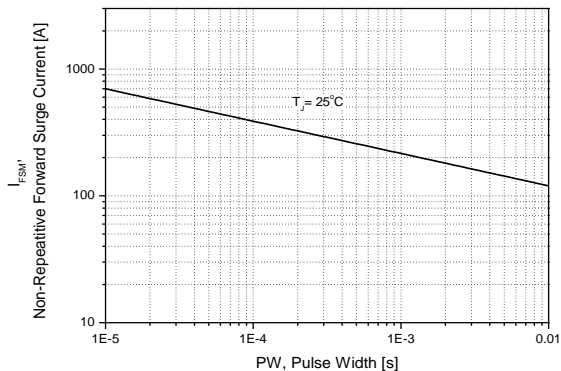

Figure 6. Non-Repetitive Peak Forward Surge Current vs. Pulse Duration

Typical Characteristics

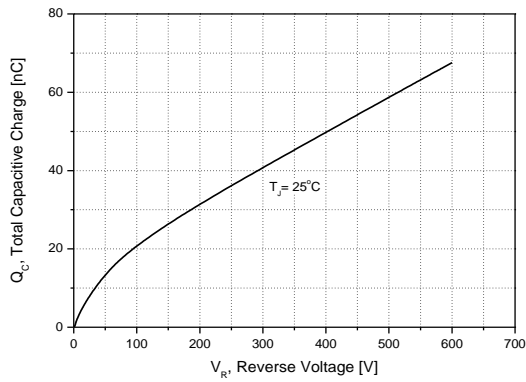

Figure 7. Total Capacitive Charge

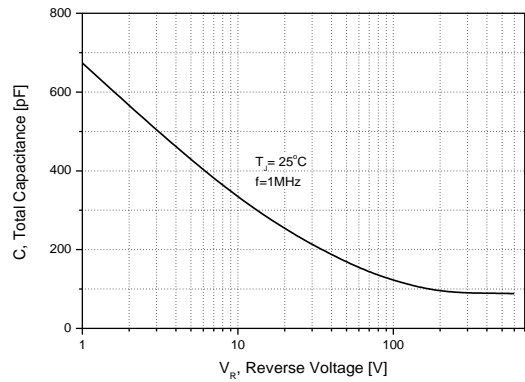

Figure 8. Total Capacitance

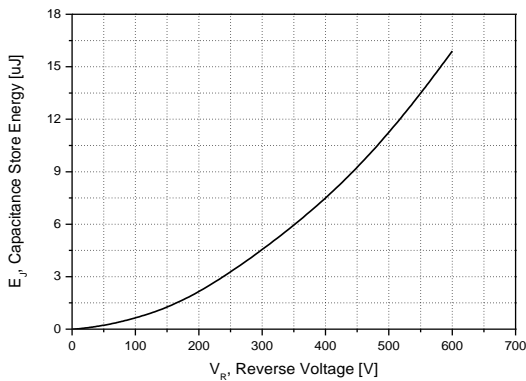

Figure 9. Capacitance Store Energy

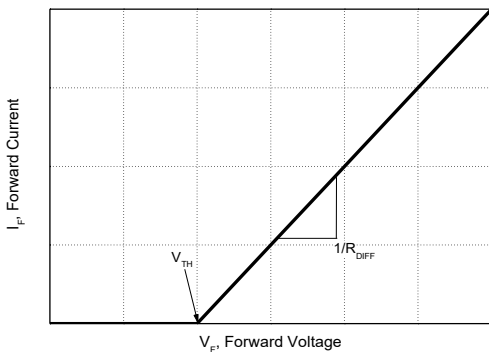

Figure 10. Equivalent Forward Current Curve

$$V_F = V_{TH} + R_{DIFF} \times I_F$$

Threshold Voltage (V_{TH})

$$V_{TH}(T_j) = -0.001 \times (T_j) + 0.950 \text{ [V]}$$

Differential Resistance (R_{DIFF})

$$R_{DIFF}(T_j) = A \times T_j^2 + B \times T_j + C \text{ [\Omega]}$$

$$A = 4.89 \times 10^{-7}$$

$$B = 1.07 \times 10^{-4}$$

$$C = 3.16 \times 10^{-2}$$

$$[T_j \text{ [}^\circ\text{C]}; -55 \text{ }^\circ\text{C} \leq T_j \leq 175 \text{ }^\circ\text{C}; I_F \leq 15 \text{ A}]$$

Package Information

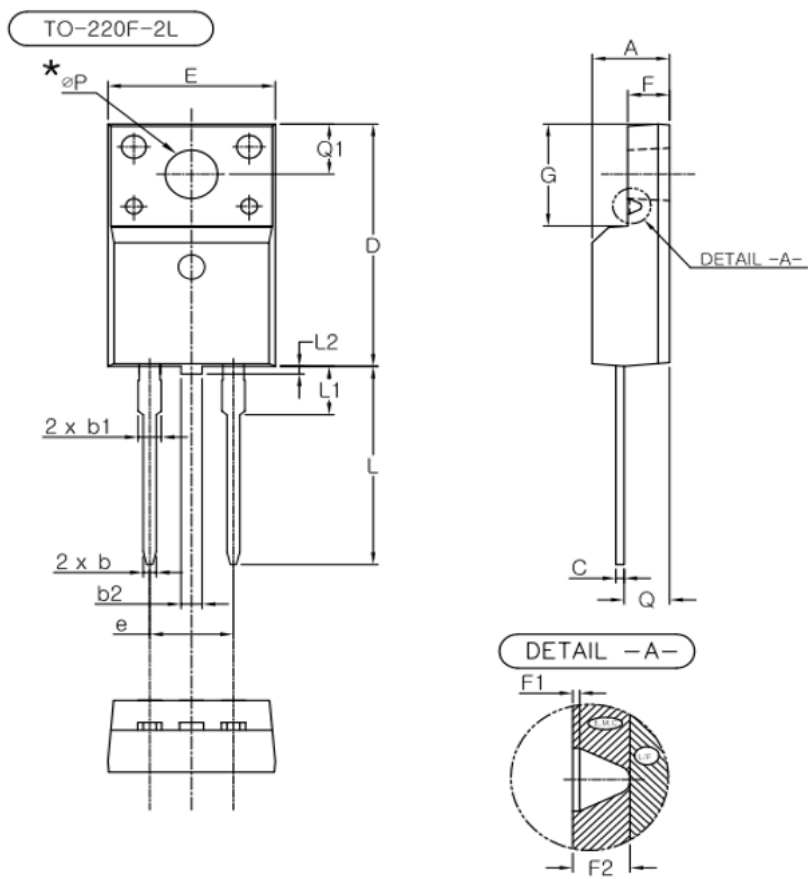

SYMBOL	MIN	NOM	MAX
A	4.50	4.70	4.90
b	0.70	0.80	0.90
b1	1.33	1.40	1.47
b2	0.98	1.28	1.58
C	0.45	0.50	0.60
D	15.67	15.87	16.07
E	9.96	10.16	10.36
e	5.08 BSC		
F	2.34	2.54	2.74
F1	(0.10)		
F2	(0.84)		
G	6.48	6.68	6.88
L	12.78	12.98	13.18
L1	2.98	3.18	3.38
L2	-	-	0.80
Q	2.56	2.76	2.96
Q1	3.10	3.30	3.50
*øP	3.08	3.18	3.28

NOTE

1. THESE DIMENSIONS DO NOT INCLUDE PROTRUSIONS OF THE MOLD.
2. THE () MARK IS THE REFERENCE
3. THE "L2" SYMBOL IS A PROTRUSION OF THE MOLD.