



# PCD25170P

## 1700V Silicon Carbide Diode

### Features

- 1700-Volt Schottky Rectifier
- Shorter recovery time
- High-speed switching possible
- High-Frequency Operation
- Temperature-Independent Switching Behavior
- Extremely Fast Switching
- Positive Temperature Coefficient on VF
- RoHS Compliant

### Applications

- Switch Mode Power Supplies
- Power Factor Correction
- Motor Drives
- HID Lighting

### Package Outline

PKG : TO-247 2L

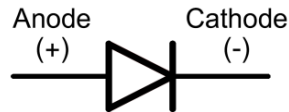

### Absolute Maximum Ratings

$T_C = 25^\circ\text{C}$  unless otherwise noted

Symbol	Parameter	Value	Units	
$V_{RRM}$	Repetitive Peak Reverse Voltage	1700	V	
$V_{RSM}$	Surge Peak Reverse Voltage	1700	V	
$V_{DC}$	DC Blocking Voltage	1700	V	
$I_F$	Continuous Forward Current	$T_C = 25^\circ\text{C}$ $T_C = 150^\circ\text{C}$	75 25	A
$I_{FRM}$	Repetitive Peak Forward Current	$T_C = 110^\circ\text{C}$	161	A
$I_{FSM}$	Non-Repetitive Forward Surge Current (PW=10ms sinusoidal)	$T_C = 25^\circ\text{C}$ $T_C = 110^\circ\text{C}$	120 96	A
$P_D$	Power Dissipation	$T_C = 25^\circ\text{C}$	428	W
$T_J, T_{stg}$	Operating Junction and Storage Temperature		-55 to +175	$^\circ\text{C}$

## Electrical Characteristics

$T_C = 25^\circ\text{C}$  unless otherwise noted

Symbol	Parameter	Test Conditions	Min	Typ	Max	Units
$V_F$	Forward Voltage	$I_F = 25\text{A}, T_C = 25^\circ\text{C}$ $I_F = 25\text{A}, T_C = 175^\circ\text{C}$	--	1.6 2.3	1.9 3.0	V
$I_R$	Reverse Current	$V_R = 1700\text{V}, T_C = 25^\circ\text{C}$ $V_R = 1700\text{V}, T_C = 175^\circ\text{C}$	--	5 20	100 -	$\mu\text{A}$
$Q_C$	Total Capacitive Charge	$V_R = 1200\text{V}$	--	188	--	nC
C	Total Capacitance	$V_R = 1\text{V}, T_J = 25^\circ\text{C}, f = 1\text{MHz}$ $V_R = 1200\text{V}, T_J = 25^\circ\text{C}, f = 1\text{MHz}$	--	1258 98	--	pF

## Thermal Characteristics

$T_C = 25^\circ\text{C}$  unless otherwise noted

Symbol	Parameter	Min	Typ	Max	Units
$R_{\theta JC}$	Thermal Resistance, Junction-to-Case	--	0.35	0.42	$^\circ\text{C}/\text{W}$

## Package Marking and Ordering Information

Device Marking	Device	Package	Reel Size	Tape Width	Quantity
P2CD25170P	P2CD25170	TO-247-2L	-	-	30

\* P2CD25170P : ROHS Compliant

# Typical Characteristics

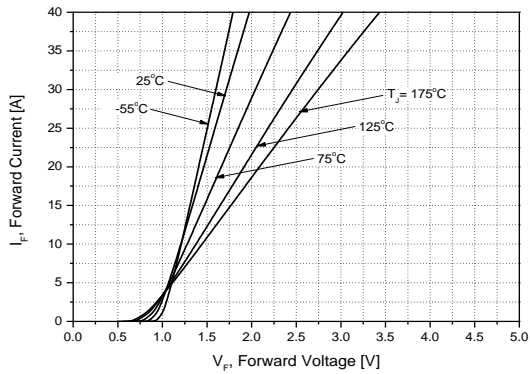

**Figure 1. Forward Characteristics**

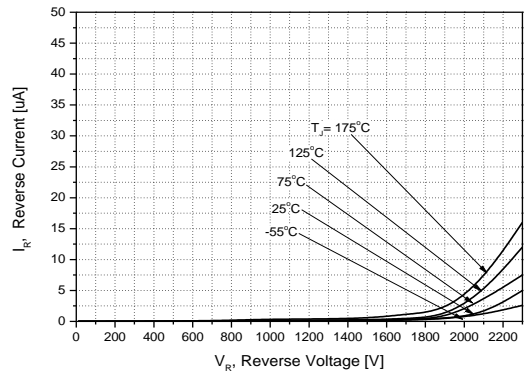

**Figure 2. Reverse Characteristics**

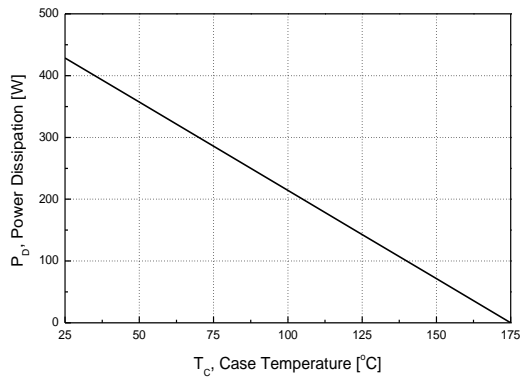

**Figure 3. Power Dissipation**

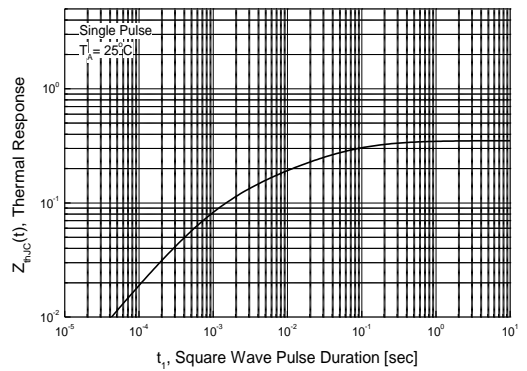

**Figure 4. Transient Thermal Resistance**

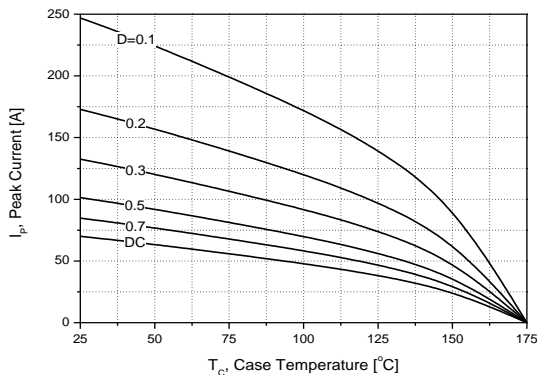

**Figure 5. Peak Forward Current Derating**

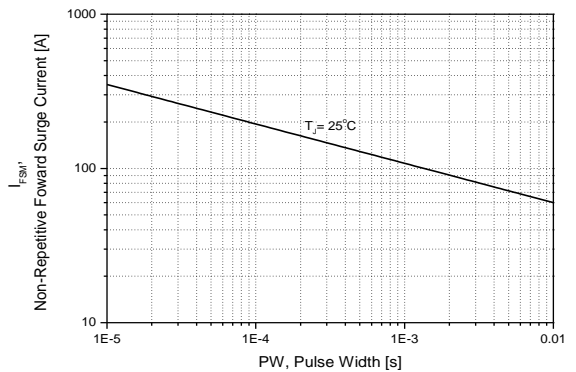

**Figure 6. Non-Repetitive Peak Forward Surge Current vs. Pulse Duration**

## Typical Characteristics

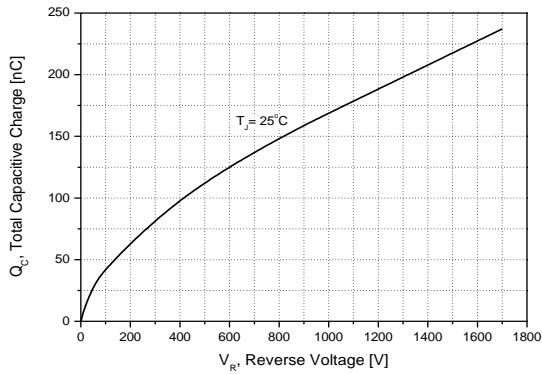

Figure 7. Total Capacitive Charge

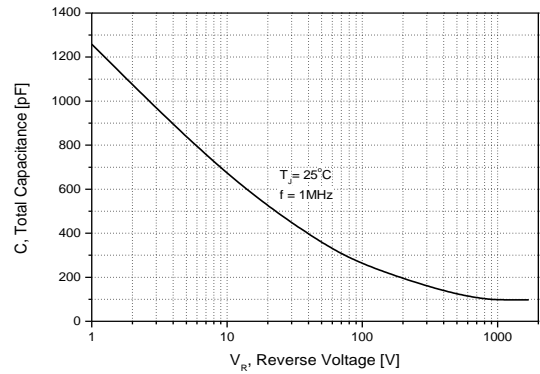

Figure 8. Total Capacitance

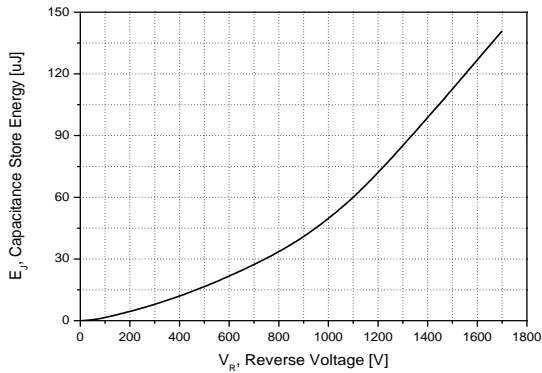

Figure 9. Capacitance Store Energy

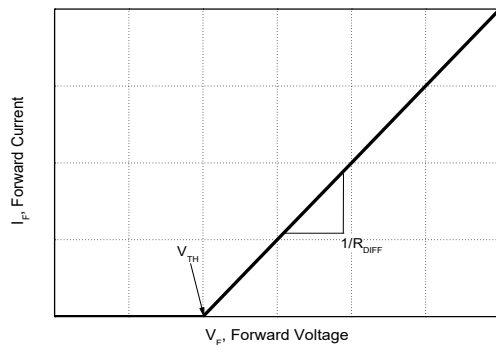

Figure 10. Equivalent Forward Current Curve

$$V_F = V_{TH} + R_{DIFF} \times I_F$$

### Threshold Voltage ( $V_{TH}$ )

$$V_{TH}(T_j) = -0.001 \times (T_j) + 0.930 \text{ [V]}$$

### Differential Resistance ( $R_{DIFF}$ )

$$R_{DIFF}(T_j) = A \times T_j^2 + B \times T_j + C \text{ [\Omega]}$$

$$A = 6.55 \times 10^{-7}$$

$$B = 1.92 \times 10^{-4}$$

$$C = 2.07 \times 10^{-2}$$

$$[T_j \text{ [}^\circ\text{C]}; -55 \text{ }^\circ\text{C} \leq T_j \leq 175 \text{ }^\circ\text{C}; I_F \leq 20 \text{ A}]$$

# Package Information

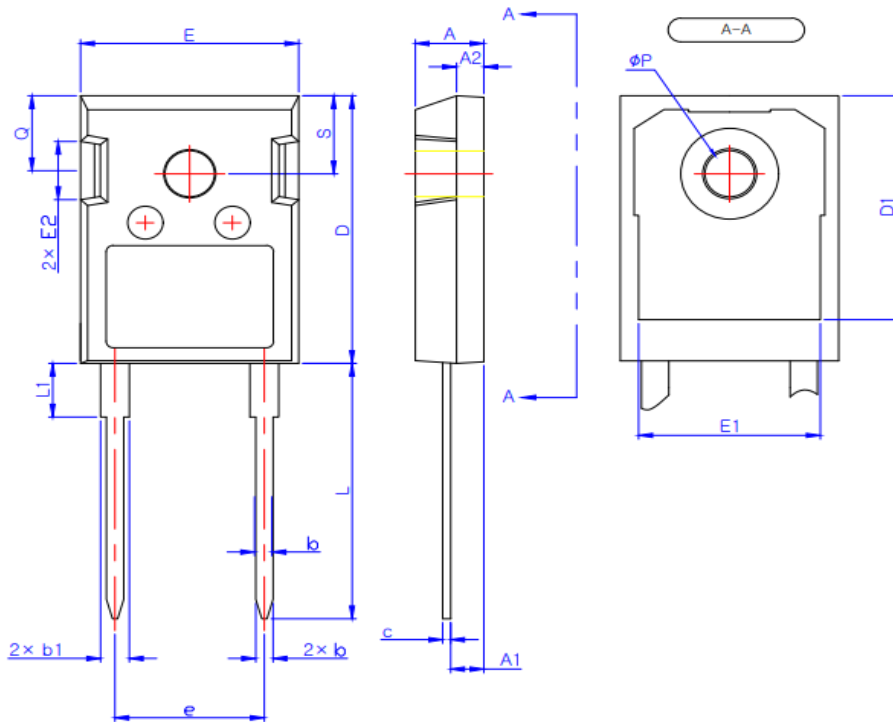

★

SYMBOL	MIN	MAX
A	4.80	5.20
A1	2.29	2.54
A2	1.90	2.10
b	1.10	1.30
b1	1.91	2.20
c	0.50	0.70
D	20.80	21.34
D1	17.43	17.83
E	15.75	16.13
E1	13.06	13.46
E2	4.32	4.83
e	10.90 BSC	
L	19.85	20.25
L1	-	4.49
$\phi P$	3.55	3.65
Q	5.59	6.19
S	6.15 BSC	

## NOTE

1. THESE DIMENSION DO NOT INCLUDE MOLD PROTRUSION