

PGT050N040LFH

40V 325A 0.5mΩ Si N-channel Enhancement Mode Split gate MOSFET

Features

Si N channel Enhancement Mode split gate MOSFET

- Rated to 40V at 325Amps @ $T_C = 25^\circ\text{C}$
- Max $R_{DS(on)} = 0.55\text{ m}\Omega$
- Gate Charge(Typ. $Q_G=121\text{ nC}$)
- Surface-mounted package
- Low Thermal Resistance

Application

- Motor Drivers
- DC-DC Converter

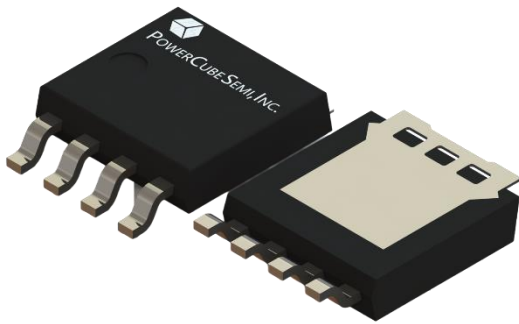

PKG type : LFPAK5060

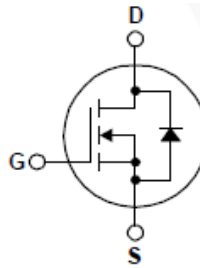

Absolute Maximum Ratings

$T_C=25^\circ\text{C}$ Unless Otherwise Noted

Symbol	Parameter	Test Condition	Value	Unit
BV_{DSS}	Drain-Source Breakdown Voltage	$V_{GS}=0V, I_D=250\mu A$	40	V
I_D^{***}	Drain Current	$V_{GS}=10V, T_C=25^\circ\text{C}$	325	A
I_{DM}^{**}	Pulsed Drain Current	$V_{GS}=10V, T_C=25^\circ\text{C}$	1300	A
V_{GS}	Gate-Source Voltage	$T_C=25^\circ\text{C}$	± 20	V
E_{AS}^*	Single Pulsed Avalanche Energy	$V_{DD}=40V, L=1.0mH$	1152	mJ
P_D^*	Power Dissipation	$T_C=25^\circ\text{C}$	375	W
T_J	Junction Temperature		175	$^\circ\text{C}$
T_{stg}	Storage Temperature		-55 to 175	$^\circ\text{C}$
$R_{\theta JA}^*$	Thermal Resistance – Junction to Ambient		42	$^\circ\text{C}/\text{W}$
$R_{\theta JC}^*$	Thermal Resistance – Junction to Case		0.4	$^\circ\text{C}/\text{W}$

Note :

* Surface Mounted on 1 in² pad area, $t \leq 10\text{ sec.}$

** Pulse Width $\leq 300\mu s$, duty cycle $\leq 1\%$

*** Limited by bonding wire

Electrical Characteristics $T_C=25^\circ\text{C}$ Unless Otherwise Noted

Static Characteristics

Symbol	Parameter	Test Condition	Numerical			Unit
			Min	Typ.	Max.	
BV_{DSS}	Drain-Source Breakdown Voltage	$V_{GS} = 0V, I_D = 250\mu A$	40	-	-	V
$V_{GS(th)}$	Gate Threshold Voltage	$V_{DS} = V_{GS}, I_D = 250\mu A$	2	-	4	V
I_{DSS}	Drain-Source Leakage Current	$V_{DS} = 32V, V_{GS} = 0V$	-	-	1	μA
I_{GSS}	Gate-Source Leakage Current	$V_{GS} = \pm 20V, V_{DS} = 0V$	-	-	± 100	nA
$R_{DS(ON)}$	Static Drain-Source on state Resistance	$V_{GS} = 10V, I_D = 50A$	-	0.50	0.55	m Ω

Dynamic Characteristics

Symbol	Parameter	Test Condition	Numerical			Unit
			Min	Typ.	Max.	
C_{iss}	Input Capacitance	$V_{GS}=0V, V_{DS}=20V, f=1\text{MHz}$	-	7204	-	pF
C_{oss}	Output Capacitance		-	2944	-	
C_{rss}	Reverse Transfer Capacitance		-	147	-	
$T_{d(on)}$	Turn-On Delay Time	$V_{DS}=20V, V_{GEN}=10V, R_G=3.9\Omega, R_L=0.4\Omega, I_{DS}=50A$	-	26	-	ns
T_r	Turn-On Rise Time		-	105	-	
$T_{d(off)}$	Turn-Off Delay Time		-	81	-	
T_f	Turn-Off Rise Time		-	72	-	

Gate Charge Characteristics

Symbol	Parameter	Test Condition	Numerical			Unit
			Min	Typ.	Max.	
Q_G	Total Gate Charge	$V_{DS}=20V, V_{GS}=10V, I_{DS}=50A$	-	121	-	nC
Q_{GS}	Gate-Source Charge		-	40	-	
Q_{GD}	Gate-Drain Charge		-	31	-	

Diode Characteristics

Symbol	Parameter	Test Condition	Numerical			Unit
			Min	Typ.	Max.	
V_{SD}	Diode Forward Voltage	$I_{SD}=50A, V_{GS}=0V$	-	-	1.3	V
T_{rr}	Reverse Recovery Time	$I_{SD}=45A, di_{SD}/dt=100A/\mu s$	-	76	-	ns
Q_{rr}	Reverse Recovery Charge		-	54	-	nC

Package Marking and Ordering Information

Device Marking	Device	Package	Packing Method	Tape width	Quantity
PGT050N040LFH	PGT050N040	LFPK5060	-	-	5000 Unit

Pin Description

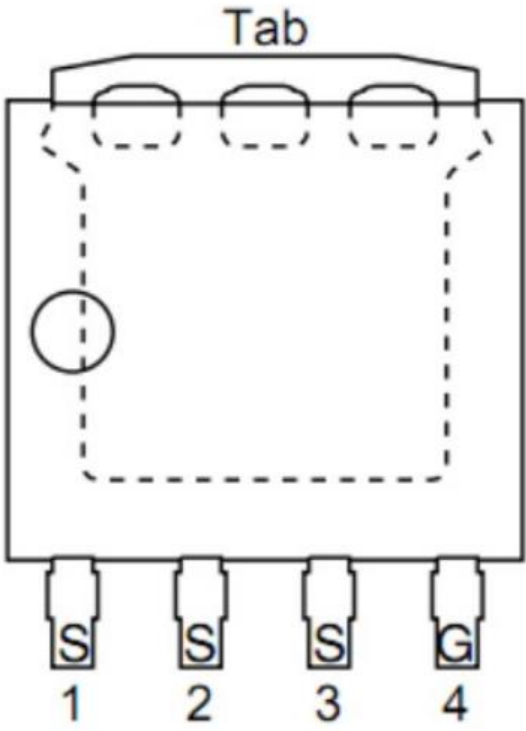
Pin	Description	Simplified Outline
1, 2, 3	Source (S)	
4	Gate (G)	
Tab	Drain (D)	

Typical Characteristics

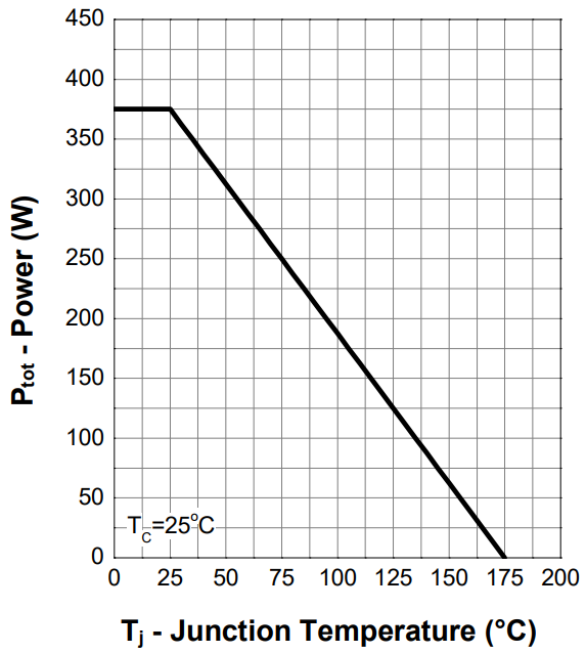

Figure 1. Power Capability

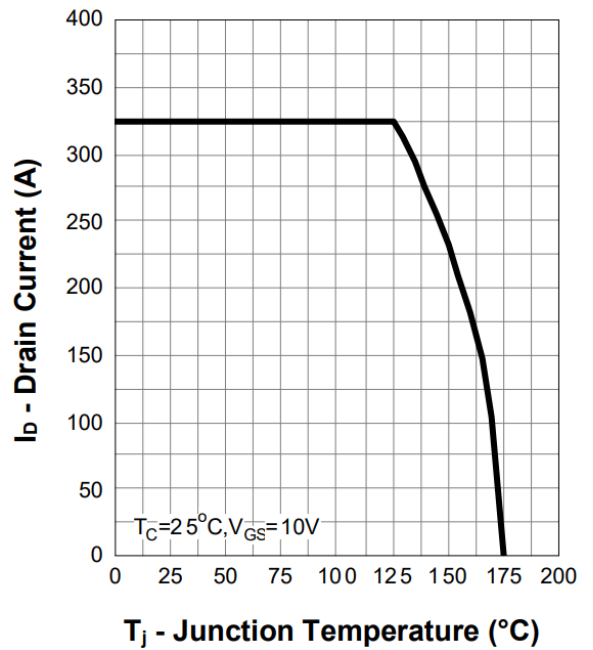

Figure 2. Current Capability

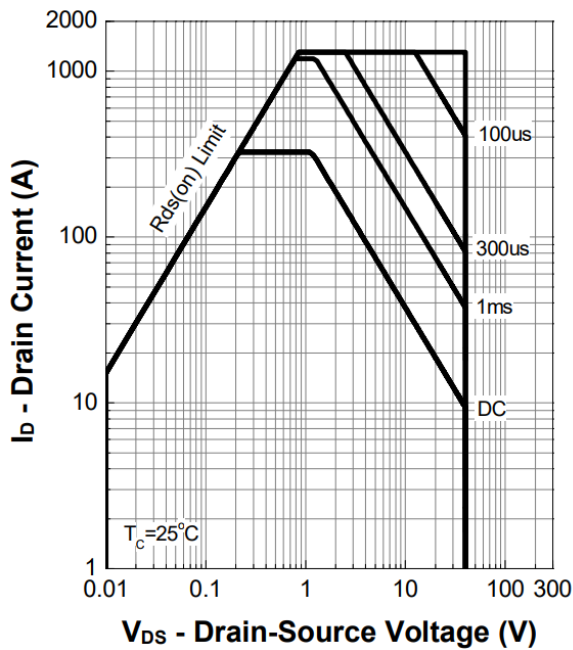

Figure 3. Safe Operating Area

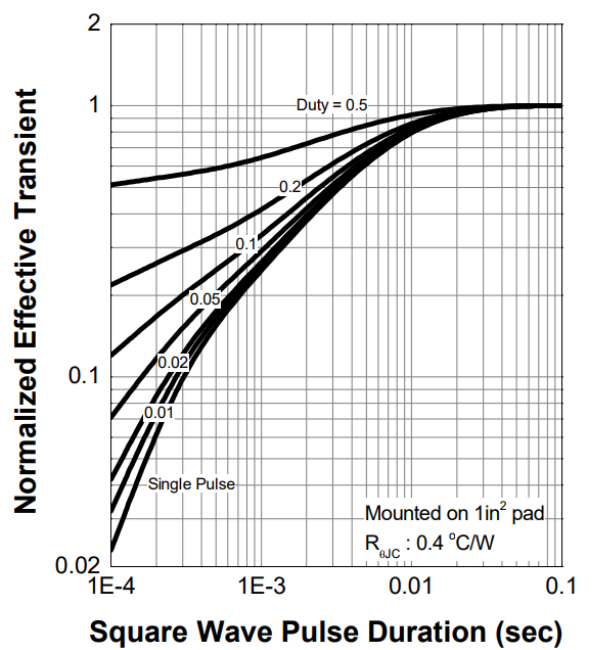

Figure 4. Transient Thermal Impedance

Typical Characteristics

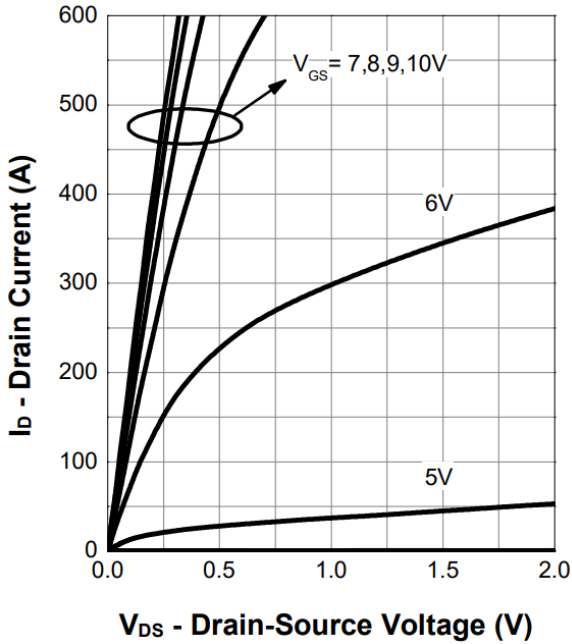

Figure 5. Output Characteristics

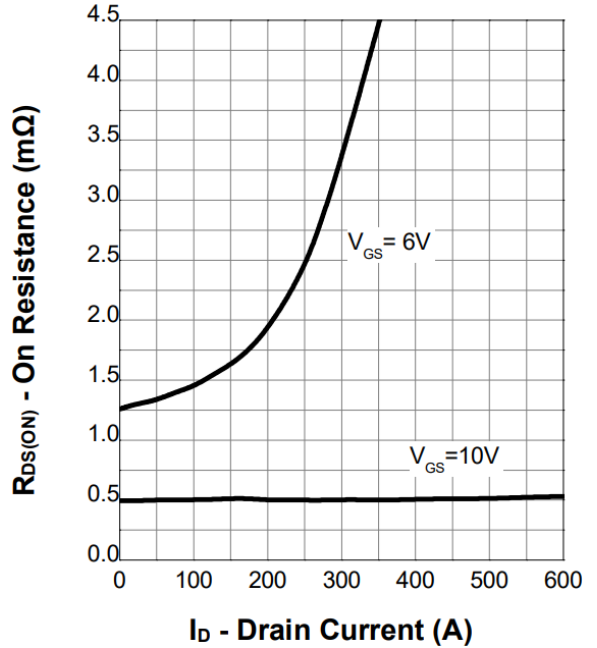

Figure 6. On-Resistance

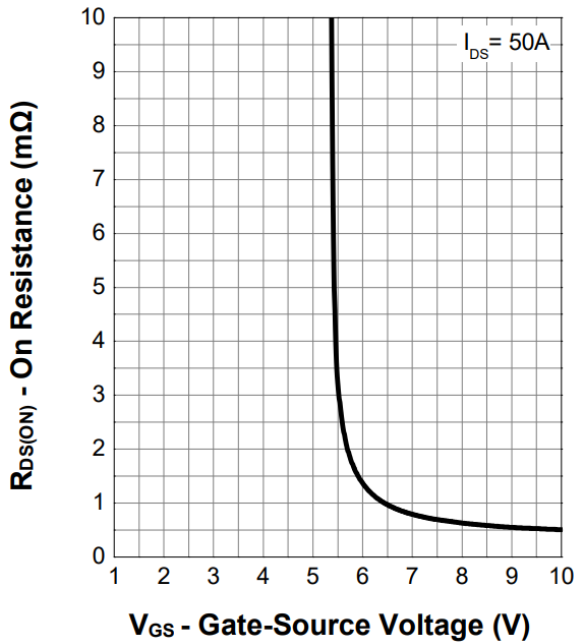

Figure 7. Transfer Characteristics

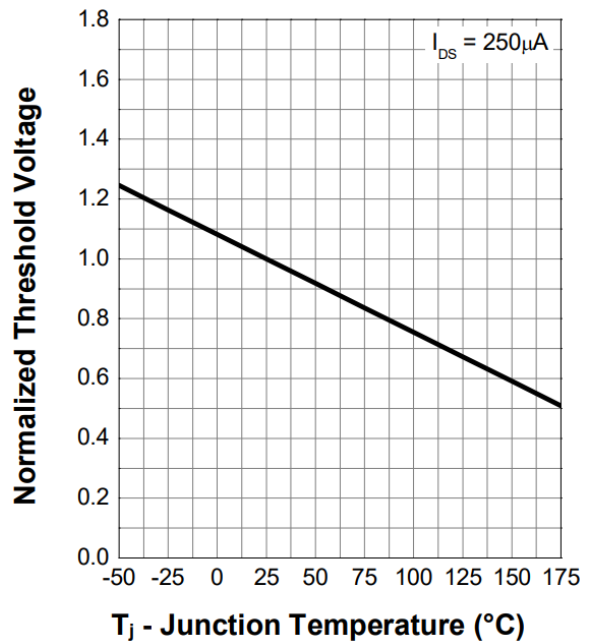

Figure 8. Normalized Threshold Voltage

Typical Characteristics

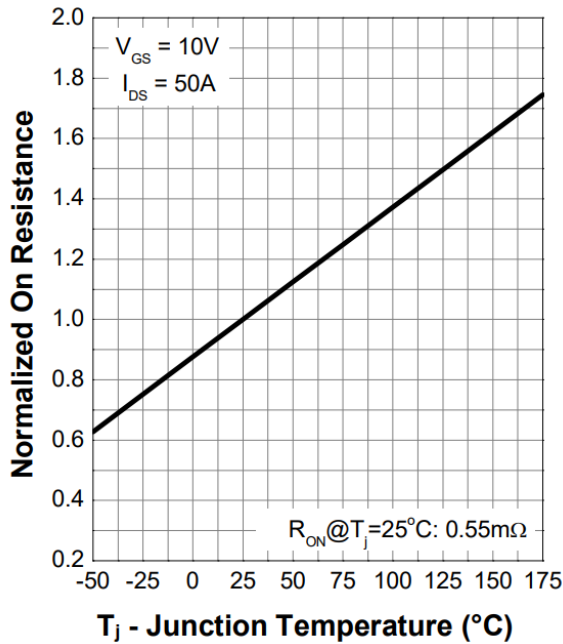

Figure 9. Normalized On-Resistance

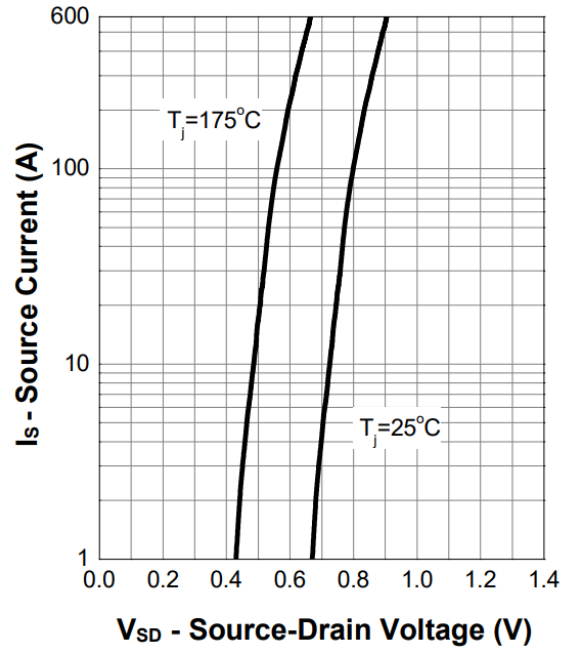

Figure 10. Diode Forward Current

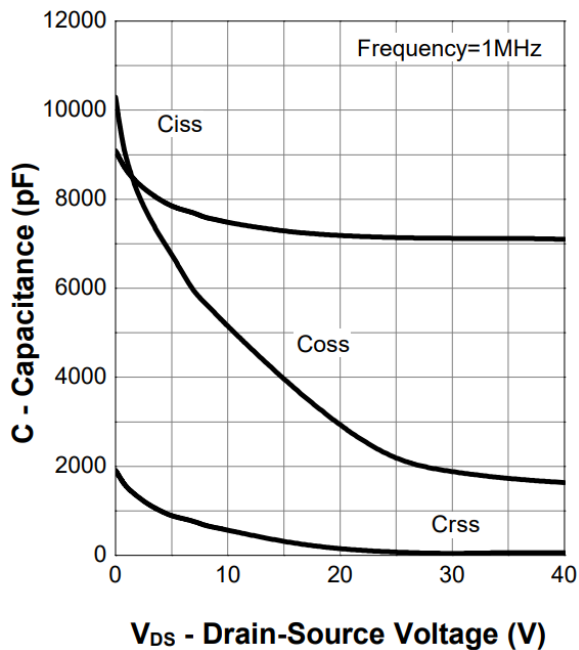

Figure 11. Capacitance

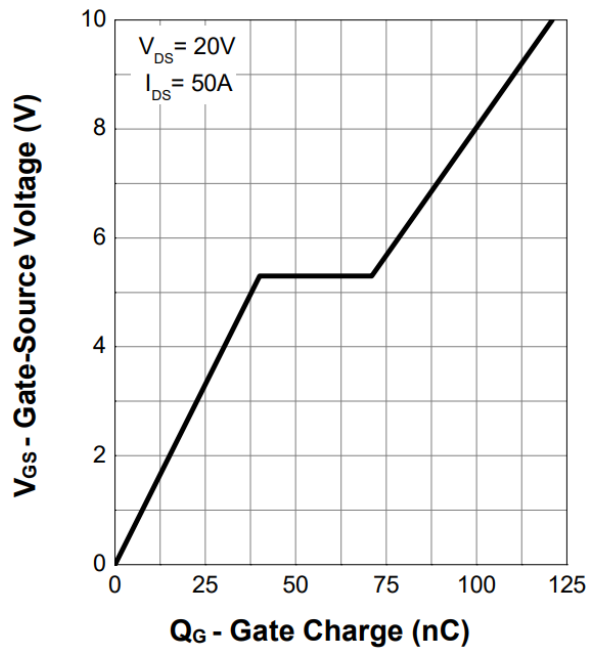
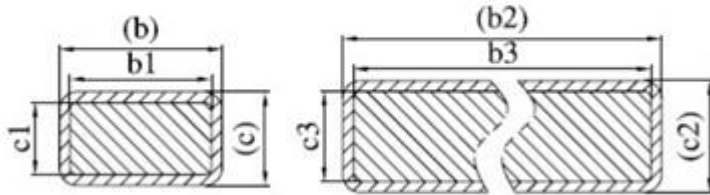
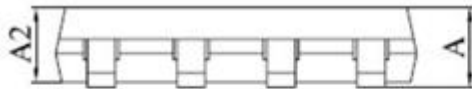
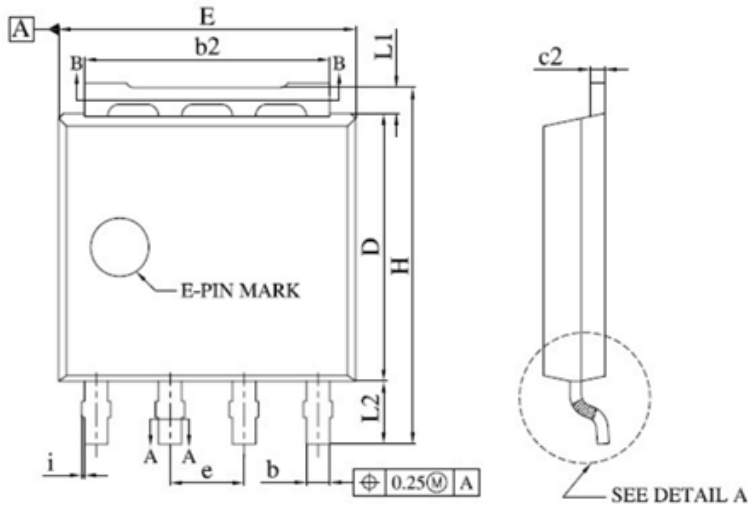

Figure 12. Gate Charge

Package Outline

Unit : mm



Section A-A

Section B-B

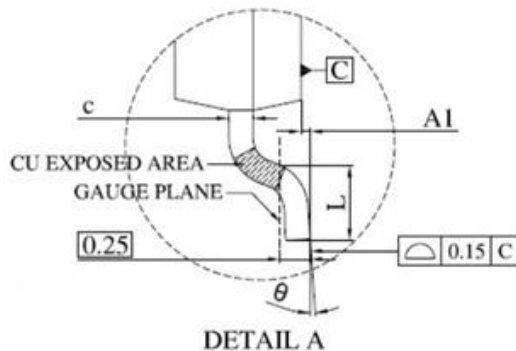
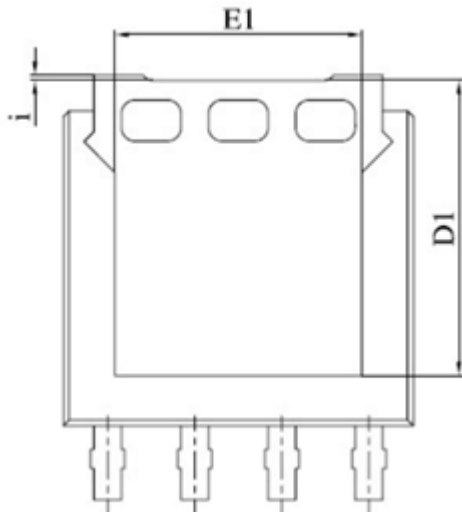

SYMBOL	DIMENSION		NOTES
	MIN	MAX	
A	1.00	1.30	
A1	0.00	0.15	
A2	0.98	1.12	
b	0.35	0.50	
b1	0.32	0.46	
b2	4.02	4.41	
b3	4.00	4.37	
c	0.19	0.25	
c1	0.17	0.23	
c2	0.24	0.30	
c3	0.22	0.28	
D	4.45	4.70	
D1	-	4.45	
E	4.95	5.30	
E1	3.50	3.70	
e	1.27 BSC		
H	5.95	6.25	
i	-	0.25	
L	0.40	0.85	
L1	0.27	0.57	
L2	0.80	1.30	
θ	0°	8°	