

PGT090N060LF

60V 326A 0.9mΩ Si N-channel Enhancement Mode Split gate MOSFET

Features

Si N channel Enhancement Mode split gate MOSFET

- Rated to 60V at 326Amps @ $T_C = 25^\circ\text{C}$
- Max $R_{DS(on)} = 0.95\text{ m}\Omega$
- Gate Charge(Typ. $Q_G=145\text{ nC}$)
- Surface-mounted package
- Advanced trench cell design
- Super Trench

Application

- Motor Drivers
- DC-DC Converter

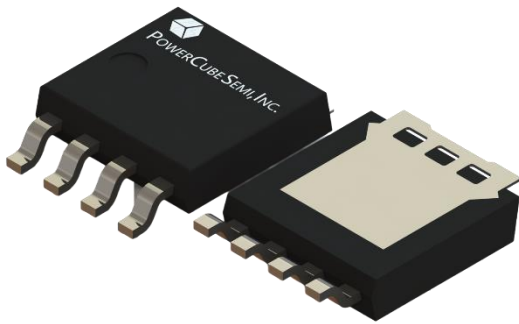

PKG type : LPAK5060

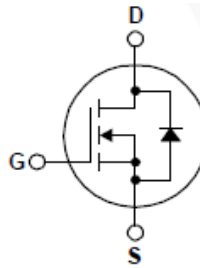

Absolute Maximum Ratings

$T_C=25^\circ\text{C}$ Unless Otherwise Noted

Symbol	Parameter	Test Condition	Value	Unit
BV_{DSS}	Drain-Source Breakdown Voltage	$V_{GS}=0V, I_D=250\mu A$	60	V
I_D^*	Drain Current	$V_{GS}=10V, T_C=25^\circ\text{C}$	326	A
I_{DM}^{**}	Pulsed Drain Current	$V_{GS}=10V, T_C=25^\circ\text{C}$	1300	A
V_{GS}	Gate-Source Voltage	$T_C=25^\circ\text{C}$	± 20	V
E_{AS}^*	Single Pulsed Avalanche Energy	$V_{DD}=40V, L=1.0mH$	1200	mJ
P_D^*	Power Dissipation	$T_C=25^\circ\text{C}$	124	W
T_J	Junction Temperature		175	$^\circ\text{C}$
T_{stg}	Storage Temperature		-55 to 175	$^\circ\text{C}$
$R_{\theta JA}^*$	Thermal Resistance – Junction to Ambient		36	$^\circ\text{C}/\text{W}$
$R_{\theta JC}^*$	Thermal Resistance – Junction to Case		0.83	$^\circ\text{C}/\text{W}$

Note :

- * Surface Mounted on 1 in² pad area, $t \leq 10\text{ sec.}$
- ** Pulse Width $\leq 300\mu s$, duty cycle $\leq 2\%$
- *** Limited by bonding wire

Electrical Characteristics $T_C=25^\circ\text{C}$ Unless Otherwise Noted

Static Characteristics

Symbol	Parameter	Test Condition	Numerical			Unit
			Min	Typ.	Max.	
$B_{V_{DS}}$	Drain-Source Breakdown Voltage	$V_{GS} = 0V, I_D = 250\mu A$	60	-	-	V
$V_{GS(th)}$	Gate Threshold Voltage	$V_{DS} = V_{GS}, I_D = 250\mu A$	1	-	2	V
I_{DSS}	Drain-Source Leakage Current	$V_{DS} = 60V, V_{GS} = 0V$	-	-	1	μA
I_{GSS}	Gate-Source Leakage Current	$V_{GS} = \pm 20V, V_{DS} = 0V$	-	-	± 100	nA
$R_{DS(ON)}$	Static Drain-Source on state Resistance	$V_{GS} = 10V, I_D = 30A$	-	0.90	0.95	m Ω

Dynamic Characteristics

Symbol	Parameter	Test Condition	Numerical			Unit
			Min	Typ.	Max.	
C_{iss}	Input Capacitance	$V_{GS}=0V, V_{DS}=20V, f=1\text{MHz}$	-	8355	-	pF
C_{oss}	Output Capacitance		-	2819	-	
C_{rss}	Reverse Transfer Capacitance		-	117	-	
$T_{d(on)}$	Turn-On Delay Time	$V_{DS}=20V, V_{GEN}=10V, R_G=4.5\Omega, R_L=0.66\Omega, I_{DS}=30A$	-	15	-	ns
T_r	Turn-On Rise Time		-	74	-	
$T_{d(off)}$	Turn-Off Delay Time		-	140	-	
T_f	Turn-Off Rise Time		-	92	-	

Gate Charge Characteristics

Symbol	Parameter	Test Condition	Numerical			Unit
			Min	Typ.	Max.	
Q_G	Total Gate Charge	$V_{DS}=20V, V_{GS}=10V, I_{DS}=30A$	-	145	-	nC
Q_{GS}	Gate-Source Charge		-	29	-	
Q_{GD}	Gate-Drain Charge		-	26	-	

Diode Characteristics

Symbol	Parameter	Test Condition	Numerical			Unit
			Min	Typ.	Max.	
V_{SD}	Diode Forward Voltage	$I_{SD}=30A, V_{GS}=0V$	-	-	1.3	V
T_{rr}	Reverse Recovery Time	$I_{SD}=30A, di_{SD}/dt=100A/\mu s$	-	87	-	ns
Q_{rr}	Reverse Recovery Charge		-	127	-	nC

Package Marking and Ordering Information

Device Marking	Device	Package	Packing Method	Tape width	Quantity
PGT090N060LF	PGT090N060	LFPK5060	-	-	-

Pin Description

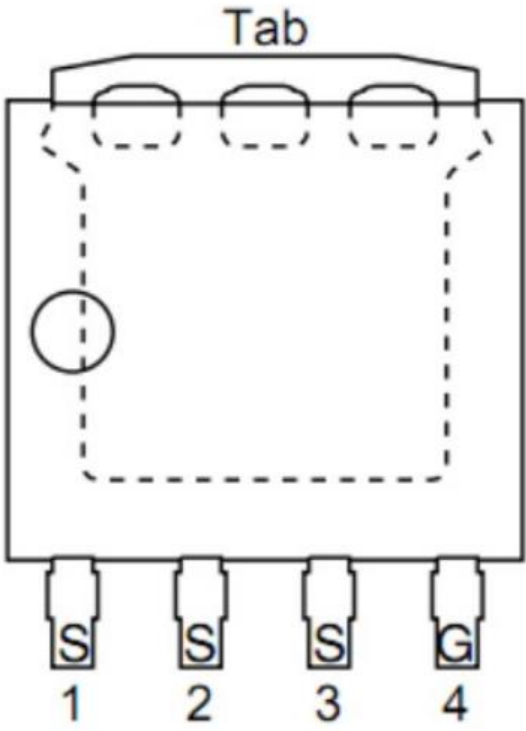
Pin	Description	Simplified Outline
1, 2, 3	Source (S)	
4	Gate (G)	
Tab	Drain (D)	

Typical Characteristics

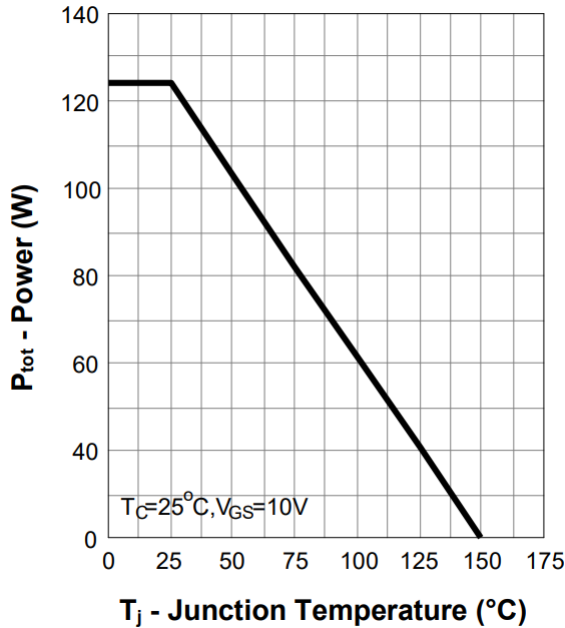

Figure 1. Power Capability

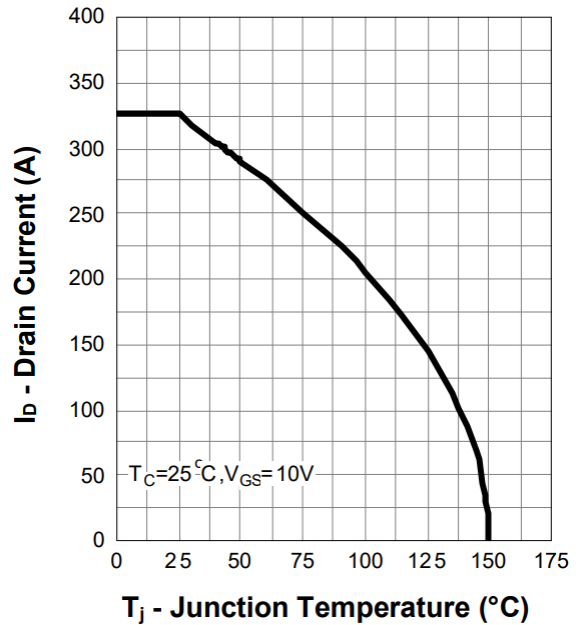

Figure 2. Current Capability

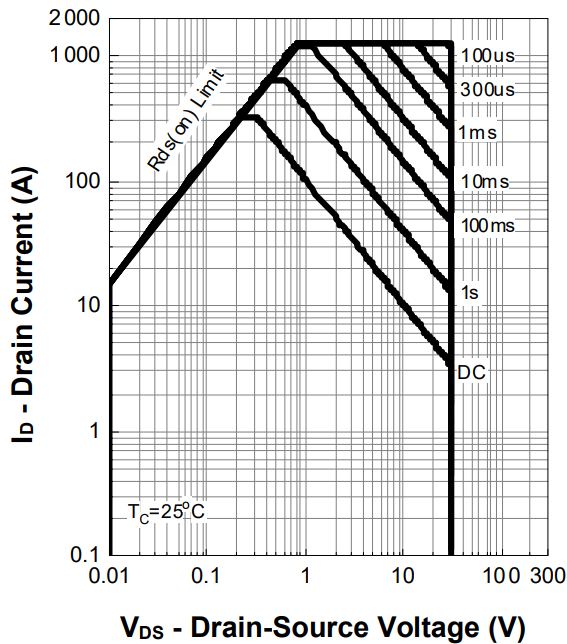

Figure 3. Safe Operating Area

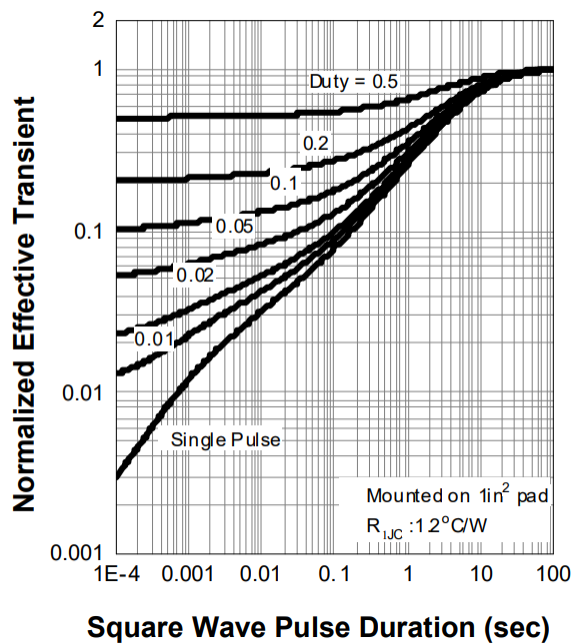

Figure 4. Transient Thermal Impedance

Typical Characteristics

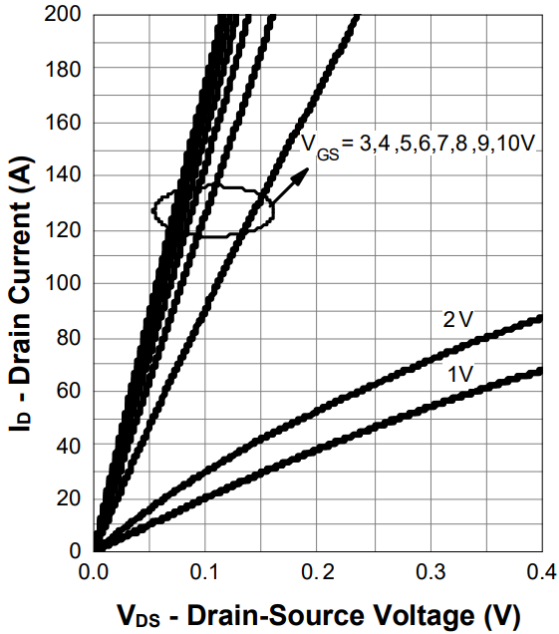

Figure 5. Output Characteristics

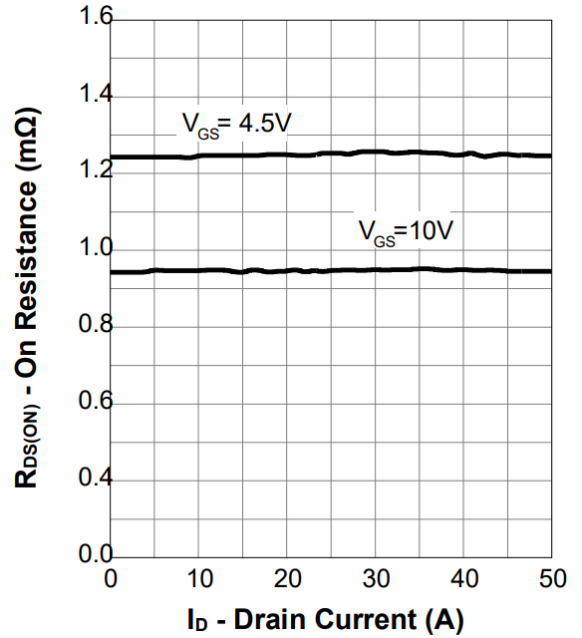

Figure 6. On-Resistance

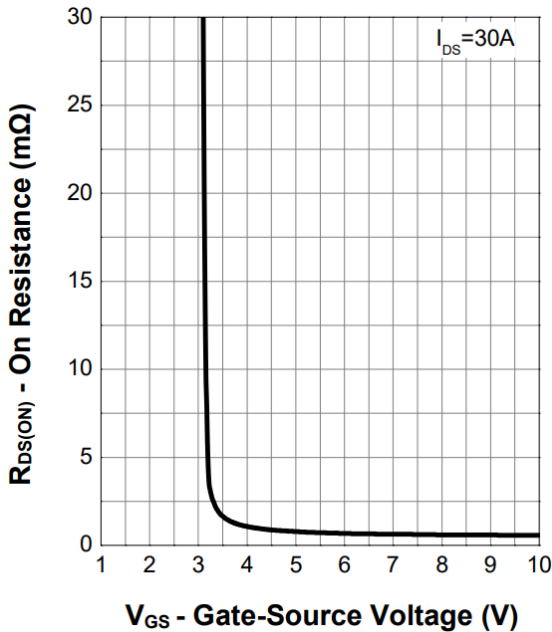

Figure 7. Transfer Characteristics

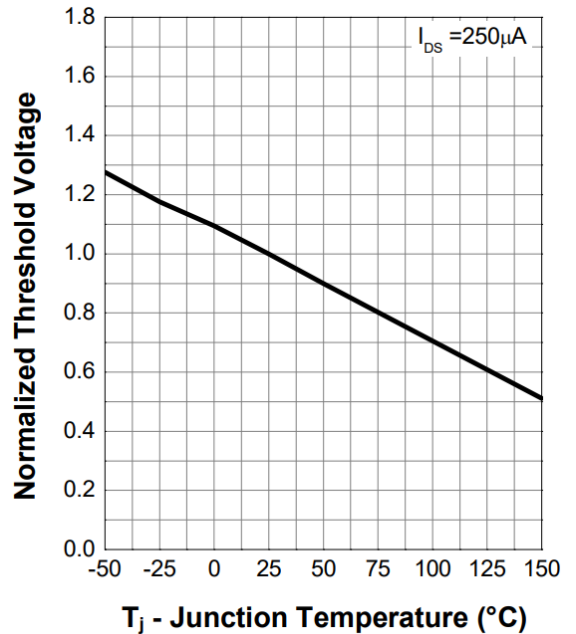
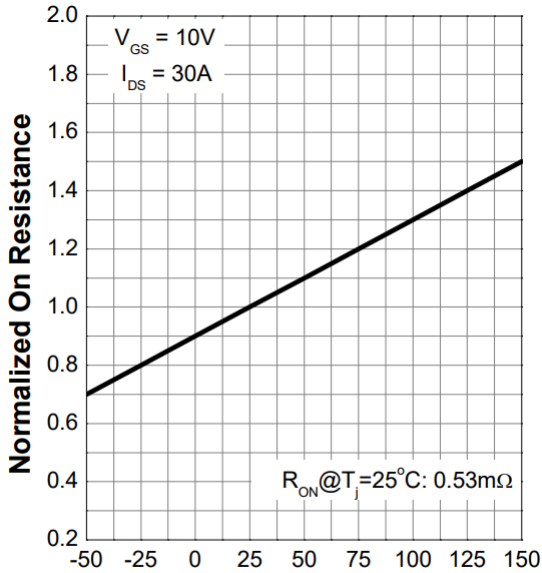

Figure 8. Normalized Threshold Voltage

Typical Characteristics



T_j - Junction Temperature (°C)

Figure 9. Normalized On-Resistance

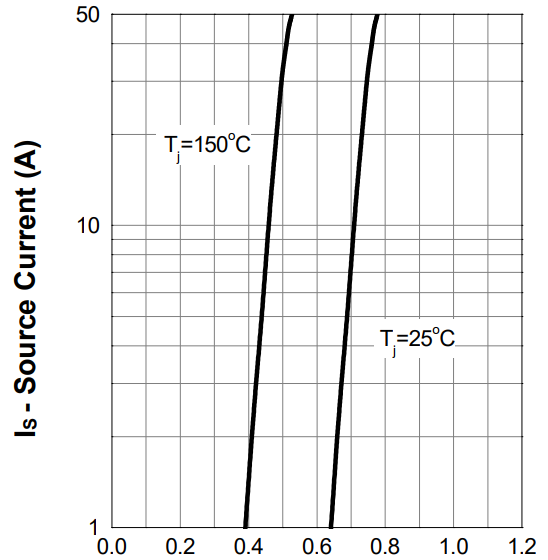

V_{SD} - Source-Drain Voltage (V)

Figure 10. Diode Forward Current

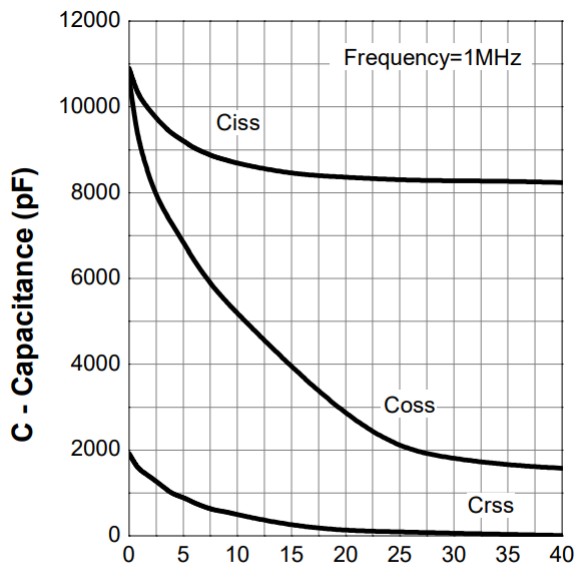

V_{DS} - Drain-Source Voltage (V)

Figure 11. Capacitance

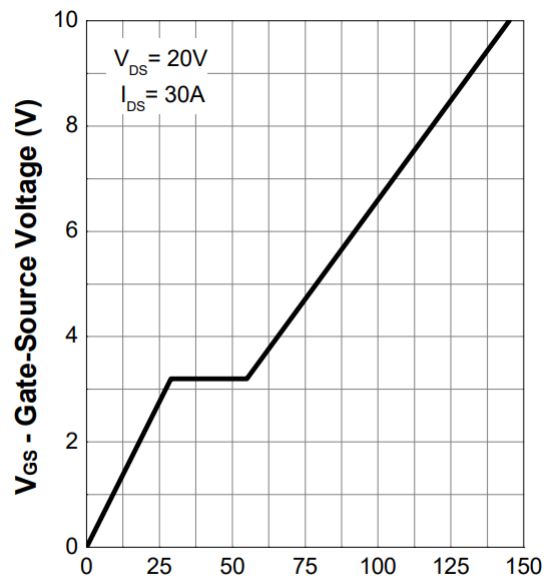

Q_G - Gate Charge (nC)

Figure 12. Gate Charge

Package Outline

Unit : mm

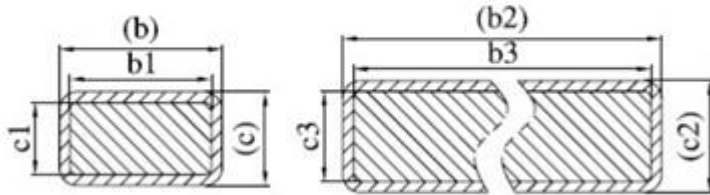
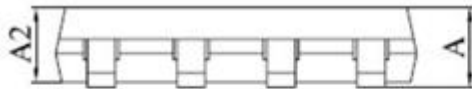
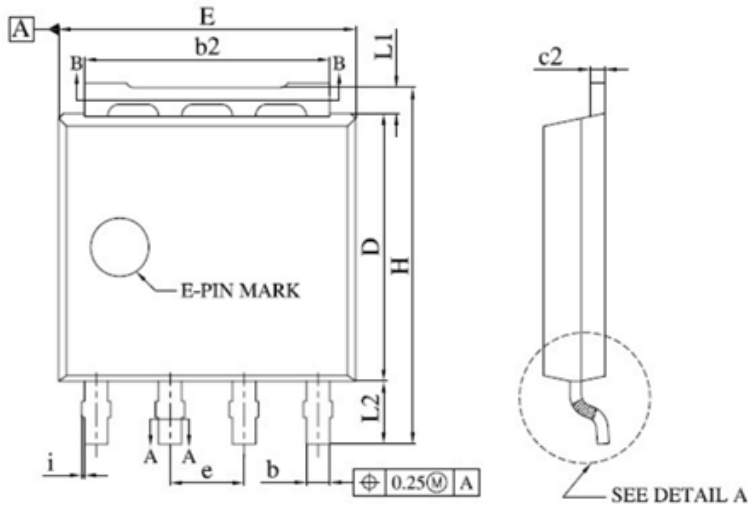

Section A-A

Section B-B

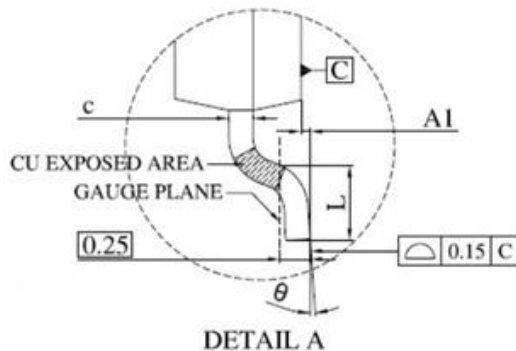
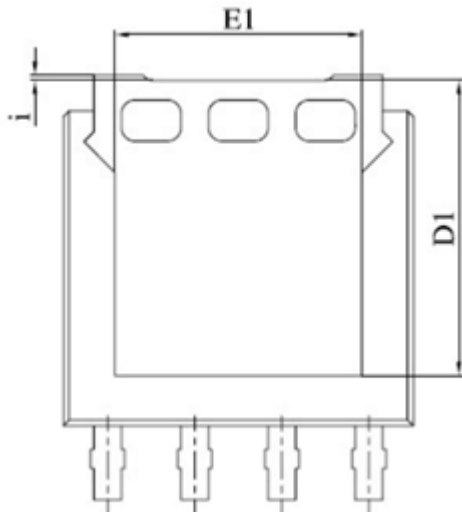

SYMBOL	DIMENSION		NOTES
	MIN	MAX	
A	1.00	1.30	
A1	0.00	0.15	
A2	0.98	1.12	
b	0.35	0.50	
b1	0.32	0.46	
b2	4.02	4.41	
b3	4.00	4.37	
c	0.19	0.25	
c1	0.17	0.23	
c2	0.24	0.30	
c3	0.22	0.28	
D	4.45	4.70	
D1	-	4.45	
E	4.95	5.30	
E1	3.50	3.70	
e	1.27 BSC		
H	5.95	6.25	
i	-	0.25	
L	0.40	0.85	
L1	0.27	0.57	
L2	0.80	1.30	
θ	0°	8°	