

PGT127N030G

30V 147A 1.27mΩ Si N-channel Enhancement Mode Split gate MOSFET



Features

Si N channel Enhancement Mode Split gate MOSFET

- Rated to 30V at 147Amps @ $T_C = 25^\circ\text{C}$
- Max $R_{DS(on)} = 1.5\text{ m}\Omega$
- Gate Charge(Typ. $Q_G=51\text{ nC}$)
- Low Thermal Resistance
- Advanced Trench Cell Design
- Super Trench
- MSL1

Application

- Motor Drivers
- DC-DC Converter

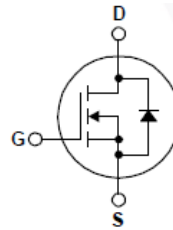
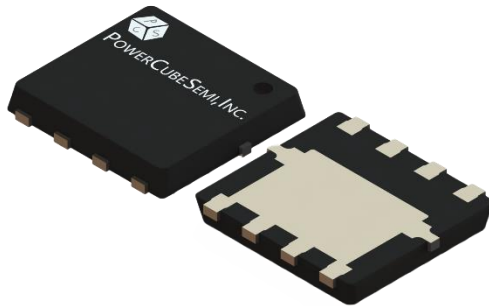

PKG type : PDFN5060-8L

Absolute Maximum Ratings

$T_C=25^\circ\text{C}$ Unless Otherwise Noted

Symbol	Parameter	Test Condition	Value	Unit
BV_{DSS}	Drain-Source Breakdown Voltage	$V_{GS}=0V, I_D=250\mu A$	30	V
I_D^*	Drain Current	$V_{GS}=10V, T_C=25^\circ\text{C}$	147	A
I_{DM}^{**}	Pulsed Drain Current	$V_{GS}=10V, T_C=25^\circ\text{C}$	588	A
V_{GS}	Gate-Source Voltage	$T_C=25^\circ\text{C}$	± 20	V
E_{AS}^*	Single Pulsed Avalanche Energy	$V_{DD}=30V, L=1.0mH$	359	mJ
P_D	Power Dissipation	$T_C=25^\circ\text{C}$	50	W
T_J	Junction Temperature		175	$^\circ\text{C}$
T_{stg}	Storage Temperature		-55 to 175	$^\circ\text{C}$
$R_{\theta JA}^*$	Thermal Resistance – Junction to Ambient		60	$^\circ\text{C}/\text{W}$
$R_{\theta JC}^*$	Thermal Resistance – Junction to Case		2.5	$^\circ\text{C}/\text{W}$

Note :

- * Surface Mounted on 1 in² pad area, $t \leq 10\text{ sec.}$
- ** Pulse Width $\leq 300\mu s$, duty cycle $\leq 2\%$
- *** Limited by bonding wire

Electrical Characteristics $T_C=25^\circ\text{C}$ Unless Otherwise Noted

Static Characteristics

Symbol	Parameter	Test Condition	Numerical			Unit
			Min	Typ.	Max.	
BV_{DSS}	Drain-Source Breakdown Voltage	$V_{GS} = 0V, I_D = 250\mu A$	30	-	-	V
$V_{GS(th)}$	Gate Threshold Voltage	$V_{DS} = V_{GS}, I_D = 250\mu A$	1	-	2	V
I_{DSS}	Drain-Source Leakage Current	$V_{DS} = 24V, V_{GS} = 0V$	-	-	1	μA
I_{GSS}	Gate-Source Leakage Current	$V_{GS} = \pm 20V, V_{DS} = 0V$	-	-	± 100	nA
$R_{DS(ON)}$	Static Drain-Source on state Resistance	$V_{GS} = 10V, I_D = 30A$	-	1.27	1.5	m Ω

Dynamic Characteristics

Symbol	Parameter	Test Condition	Numerical			Unit
			Min	Typ.	Max.	
C_{iss}	Input Capacitance	$V_{GS}=0V, V_{DS}=15V, f=1\text{MHz}$	-	2729	-	pF
C_{oss}	Output Capacitance		-	1057	-	
C_{rss}	Reverse Transfer Capacitance		-	171	-	
$T_{d(on)}$	Turn-On Delay Time	$V_{DS}=15V, V_{GEN}=10V, R_G=3.9\Omega, R_L=0.5\Omega, I_{DS}=30A$	-	9.5	-	ns
T_r	Turn-On Rise Time		-	83	-	
$T_{d(off)}$	Turn-Off Delay Time		-	51	-	
T_f	Turn-Off Rise Time		-	41	-	

Gate Charge Characteristics

Symbol	Parameter	Test Condition	Numerical			Unit
			Min	Typ.	Max.	
Q_G	Total Gate Charge	$V_{DS}=15V, V_{GS}=10V, I_{DS}=30A$	-	51	-	nC
Q_{GS}	Gate-Source Charge		-	9.8	-	
Q_{GD}	Gate-Drain Charge		-	9.2	-	

Diode Characteristics

Symbol	Parameter	Test Condition	Numerical			Unit
			Min	Typ.	Max.	
V_{SD}	Diode Forward Voltage	$I_{SD}=30A, V_{GS}=0V$	-	-	1.3	V
T_{rr}	Reverse Recovery Time	$I_{SD}=30A, dI_{SD}/dt=100A/\mu s$	-	38	-	ns
Q_{rr}	Reverse Recovery Charge		-	27	-	nC

Package Marking and Ordering Information

Device Marking	Device	Package	Packing Method	Tape width	Quantity
PGT127N030G	PGT127N030	PDFN5060	-	-	5000 unit

Pin Description

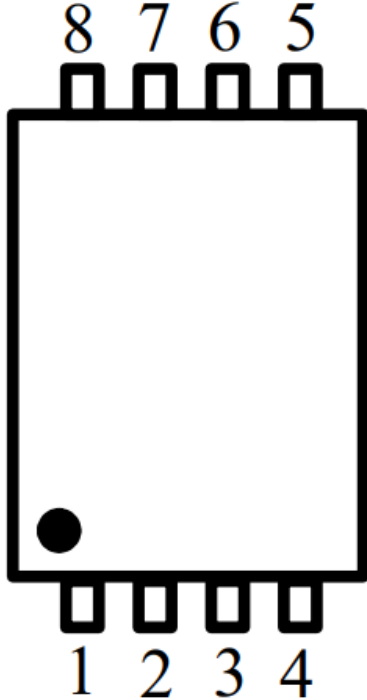
Pin	Description	Simplified Outline
1, 2, 3	Source (S)	
4	Gate (G)	
5, 6, 7, 8	Drain (D)	

Typical Characteristics

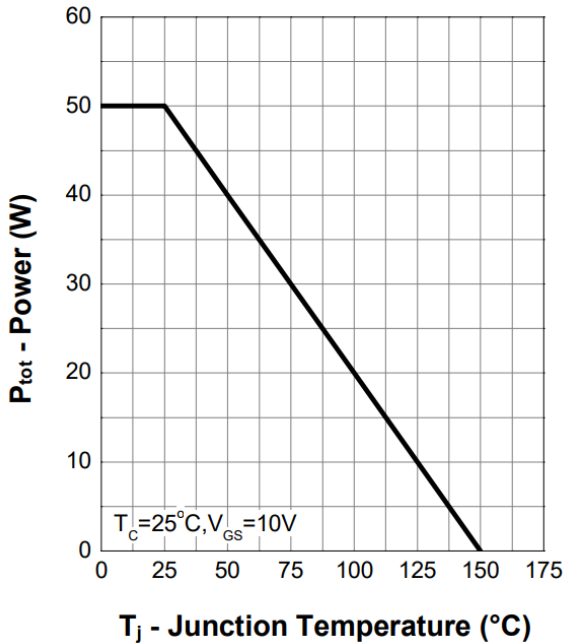

Figure 1. Power Capability

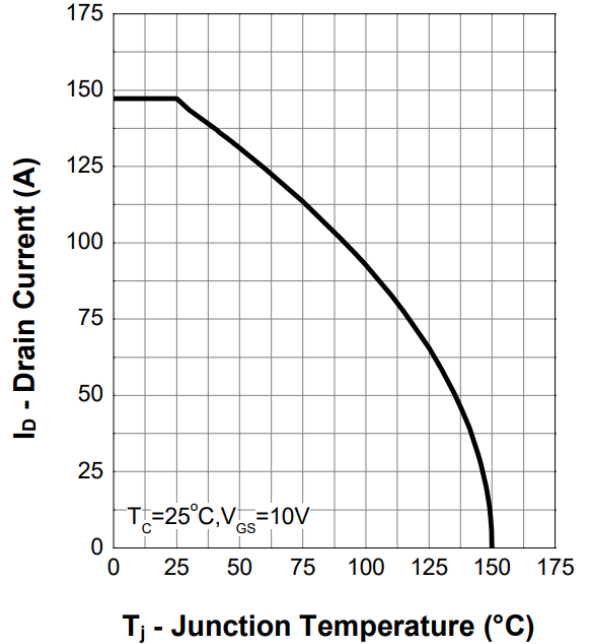

Figure 2. Current Capability

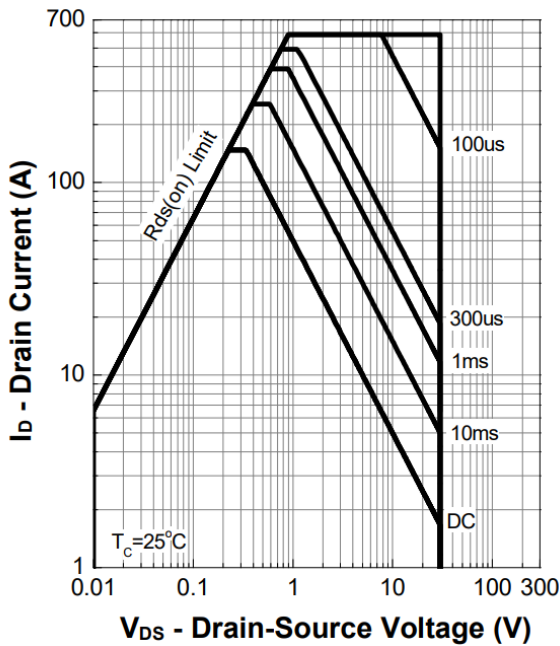

Figure 3. Safe Operating Area

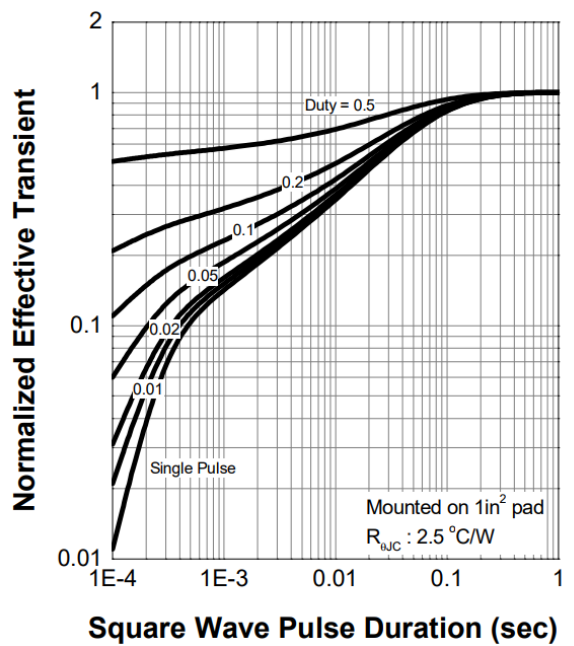

Figure 4. Transient Thermal Impedance

Typical Characteristics

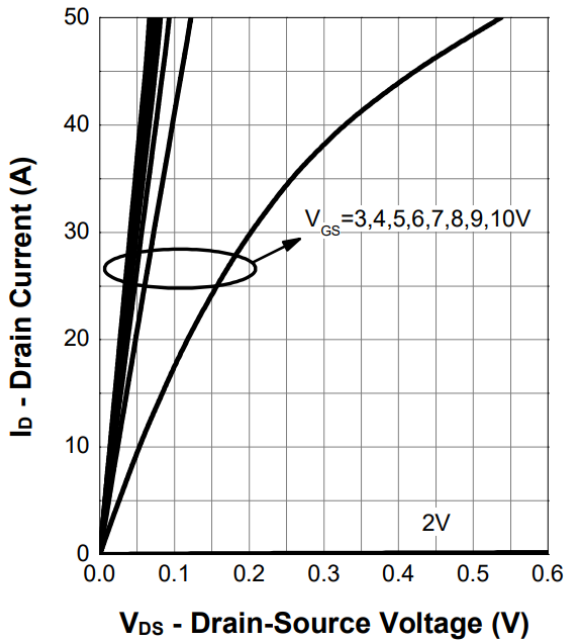

Figure 5. Output Characteristics

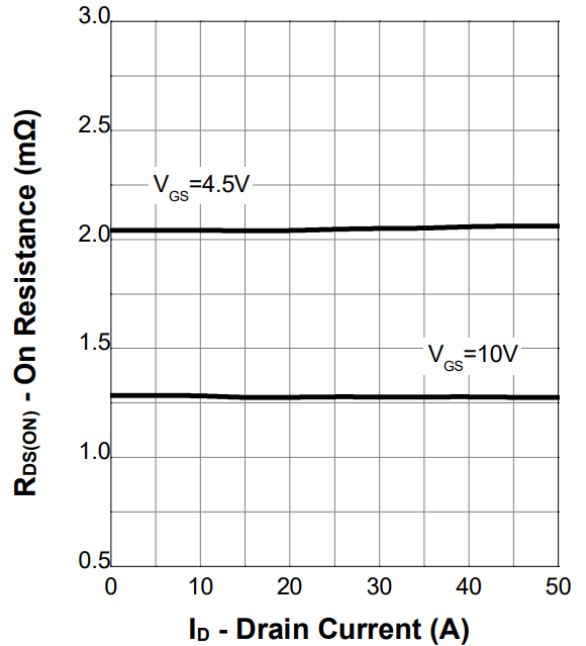

Figure 6. On-Resistance

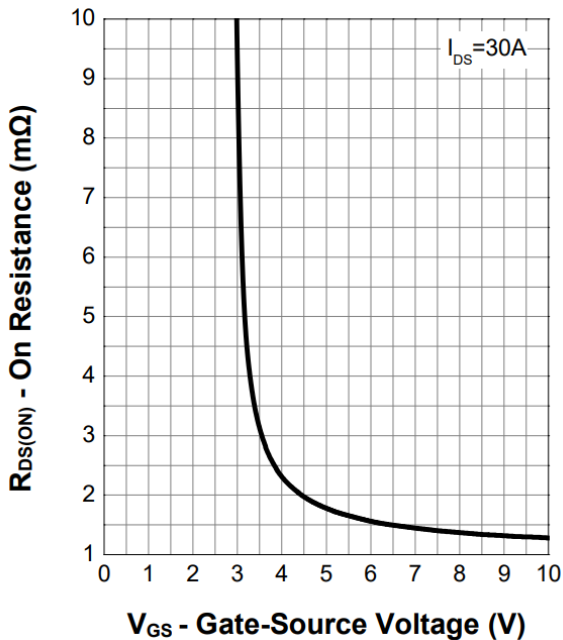

Figure 7. Transfer Characteristics

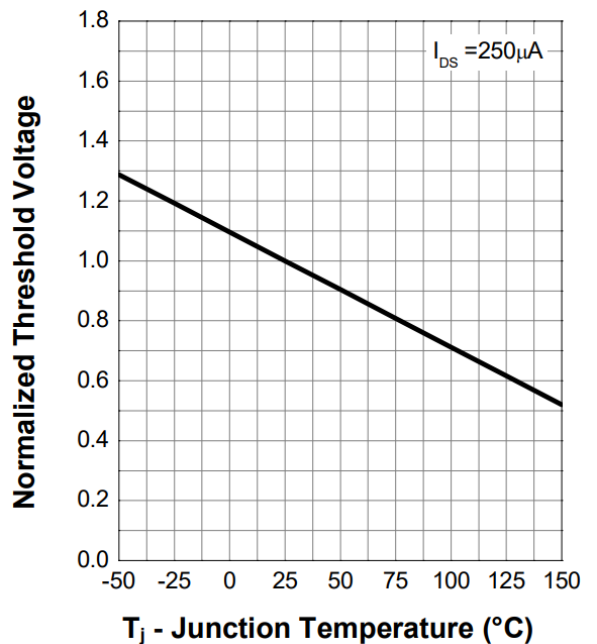

Figure 8. Normalized Threshold Voltage

Typical Characteristics

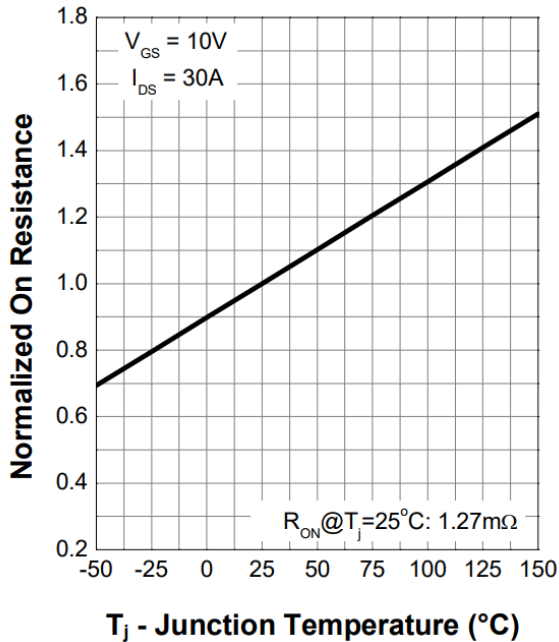

Figure 9. Normalized On-Resistance

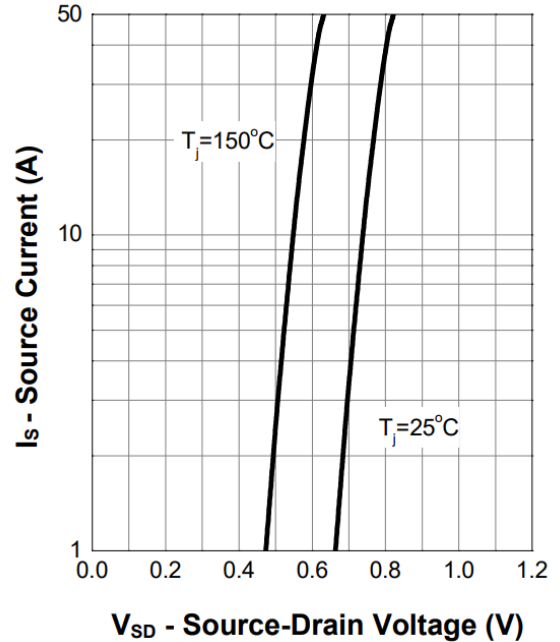

Figure 10. Diode Forward Current

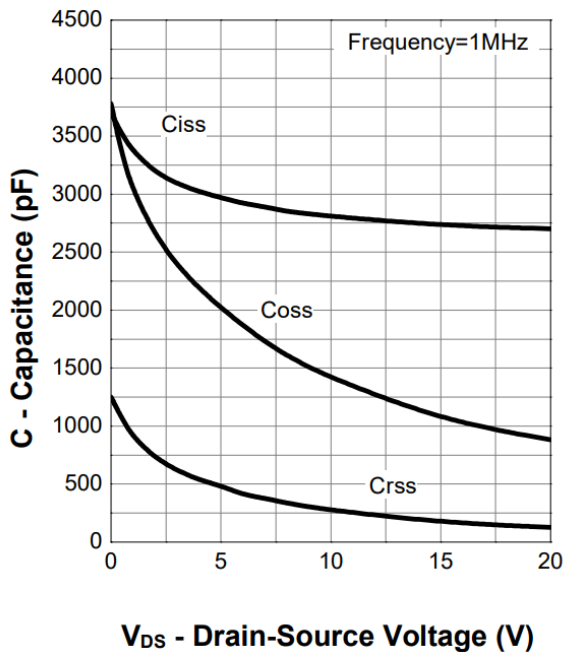

Figure 11. Capacitance

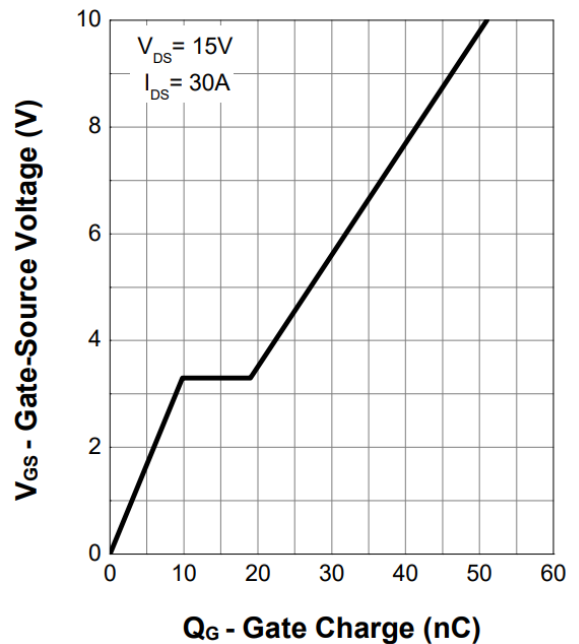
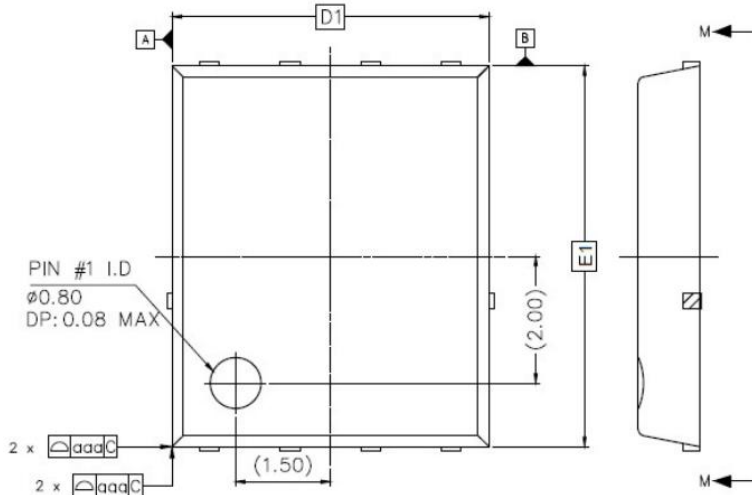

Figure 12. Gate Charge

Package Outline

Unit : mm



SYMBOL	DIMENSION		NOTES
	MIN	MAX	
A	0.95	1.05	
A1	0.00	0.05	
A3	0.254 REF		
b	0.31	0.51	
b1	0.03	0.13	
b2	0.21	0.41	
D	5.15 BSC		
D1	5.00 BSC		
D2	3.70	3.90	
E	6.15 BSC		
E1	6.00 BSC		
E2	3.56	3.76	
e	1.27 BSC		
L	0.51	0.71	
M	0.51	0.71	
P	10°	12°	
aaa	0.10		
bbb	0.10		
ccc	0.10		
ddd	0.05		
eee	0.08		

