

PGT570N030Q

30V 50A 5.7mΩ Si N-channel Enhancement Mode Split gate MOSFET

Features

Si N channel Enhancement Mode Split gate MOSFET

- Rated to 30V at 50Amps @ $T_C = 25^\circ\text{C}$
- Max $R_{DS(on)} = 6.5\text{ m}\Omega$
- Gate Charge(Typ. $Q_G=22\text{ nC}$)
- Surface-mounted package
- Advanced Trench Cell Design

Application

- High power inverter system
- Motor Applications

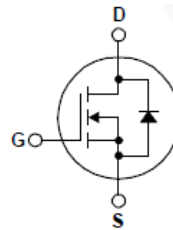
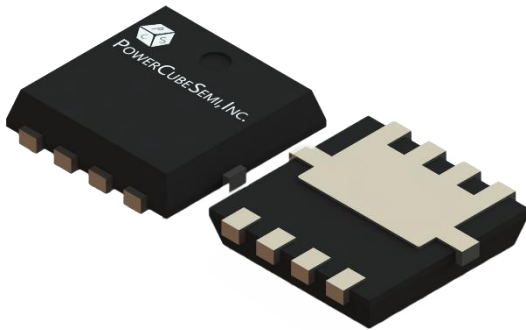

PKG type : PDFN3333

Absolute Maximum Ratings

$T_C=25^\circ\text{C}$ Unless Otherwise Noted

Symbol	Parameter	Test Condition	Value	Unit
BV_{DSS}	Drain-Source Breakdown Voltage	$V_{GS}=0V, I_D=250\mu A$	30	V
I_D^*	Drain Current	$V_{GS}=10V, T_C=25^\circ\text{C}$	50	A
		$V_{GS}=10V, T_C=100^\circ\text{C}$	30	
$I_{DM}^{*,**}$	Pulsed Drain Current	$V_{GS}=10V, T_C=25^\circ\text{C}$	50	A
V_{GS}	Gate-Source Voltage	$T_C=25^\circ\text{C}$	± 20	V
P_D	Power Dissipation	$T_C=25^\circ\text{C}$	35	W
T_J	Junction Temperature		150	$^\circ\text{C}$
T_{stg}	Storage Temperature		-55 to 150	$^\circ\text{C}$
$R_{\theta JA}^*$	Thermal Resistance – Junction to Ambient		62.5	$^\circ\text{C}/\text{W}$

Note :

* Surface Mounted on 1 in² pad area, $t \leq 10\text{ sec}$

** Pulse Width $\leq 300\mu\text{s}$, duty cycle $\leq 2\%$

*** Limited by bonding wire

Electrical Characteristics $T_C=25^\circ\text{C}$ Unless Otherwise Noted

Static Characteristics

Symbol	Parameter	Test Condition	Numerical			Unit
			Min	Typ.	Max.	
BV_{DSS}	Drain-Source Breakdown Voltage	$V_{GS} = 0V, I_D = 250\mu A$	30	-	-	V
$V_{GS(th)}$	Gate Threshold Voltage	$V_{DS} = V_{GS}, I_D = 250\mu A$	1	-	2	V
I_{DSS}	Drain-Source Leakage Current	$V_{DS} = 24V, V_{GS} = 0V$	-	-	1	μA
I_{GSS}	Gate-Source Leakage Current	$V_{GS} = \pm 20V, V_{DS} = 0V$	-	-	± 100	nA
$R_{DS(ON)}$	Static Drain-Source on state Resistance	$V_{GS} = 10V, I_D = 10A$	-	5.7	6.5	m Ω

Dynamic Characteristics

Symbol	Parameter	Test Condition	Numerical			Unit
			Min	Typ.	Max.	
C_{iss}	Input Capacitance	$V_{GS}=0V, V_{DS}=15V, f=1\text{MHz}$	-	1145	-	pF
C_{oss}	Output Capacitance		-	106	-	
C_{rss}	Reverse Transfer Capacitance		-	87	-	
$T_{d(on)}$	Turn-On Delay Time	$V_{DS}=15V, V_{GEN}=10V, R_G=4.5\Omega, R_L=1.5\Omega, I_{DS}=10A$	-	7	-	ns
T_r	Turn-On Rise Time		-	30	-	
$T_{d(off)}$	Turn-Off Delay Time		-	19	-	
T_f	Turn-Off Rise Time		-	18	-	

Gate Charge Characteristics

Symbol	Parameter	Test Condition	Numerical			Unit
			Min	Typ.	Max.	
Q_G	Total Gate Charge	$V_{DS}=10V, V_{GS}=15V, I_{DS}=10A$	-	22	-	nC
Q_{GS}	Gate-Source Charge		-	5	-	
Q_{GD}	Gate-Drain Charge		-	3.3	-	

Diode Characteristics

Symbol	Parameter	Test Condition	Numerical			Unit
			Min	Typ.	Max.	
V_{SD}	Diode Forward Voltage	$I_{SD}=10A, V_{GS}=0V$	-	-	1.3	V
T_{rr}	Reverse Recovery Time	$I_{DS}=10A, V_{GS}=0V, di_{SD}/dt=100A/\mu s$	-	34	-	ns
Q_{rr}	Reverse Recovery Charge		-	7.1	-	μC

Package Marking and Ordering Information

Device Marking	Device	Package	Packing Method	Tape width	Quantity
PGT570N030Q	PGT570N030	PDFN3333			5000 Unit

Pin Description

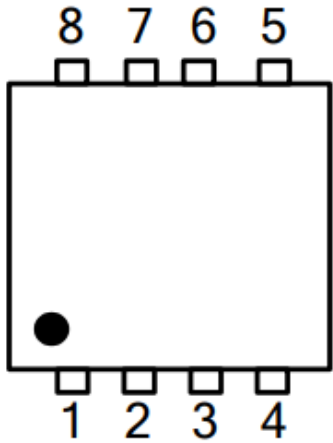
Pin	Description	Simplified Outline
1, 2, 3	Source (S)	
4	Gate (G)	
5, 6, 7, 8	Drain (D)	

Typical Characteristics

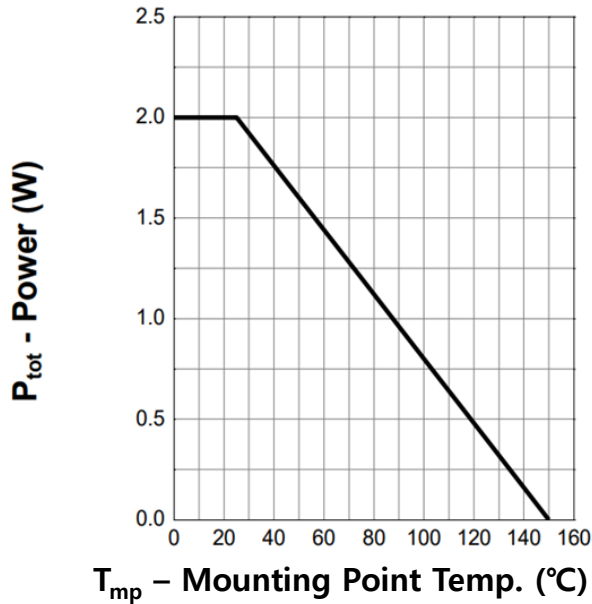

Figure 1. Power Capability

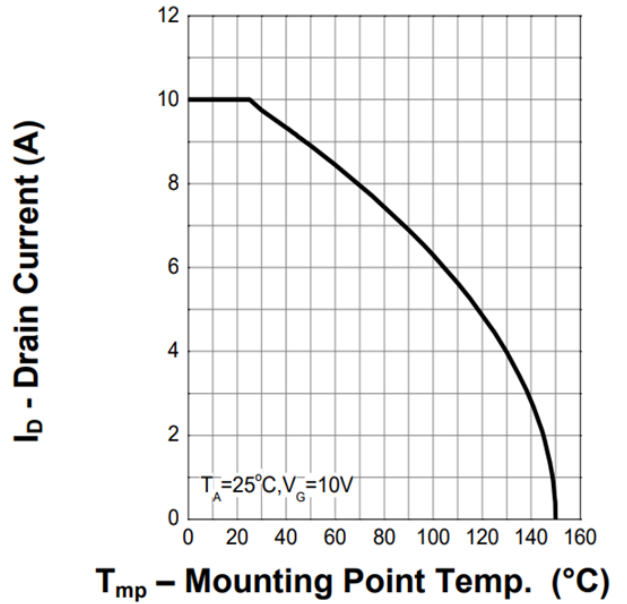

Figure 2. Current Capability

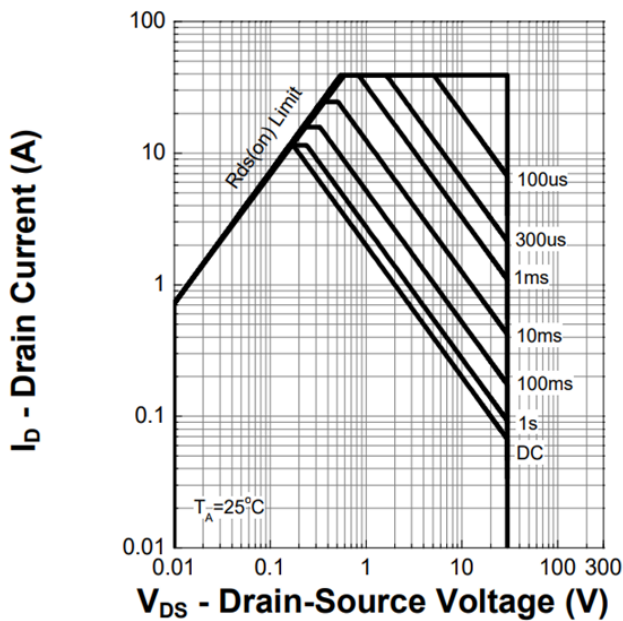

Figure 3. Safe Operating Area

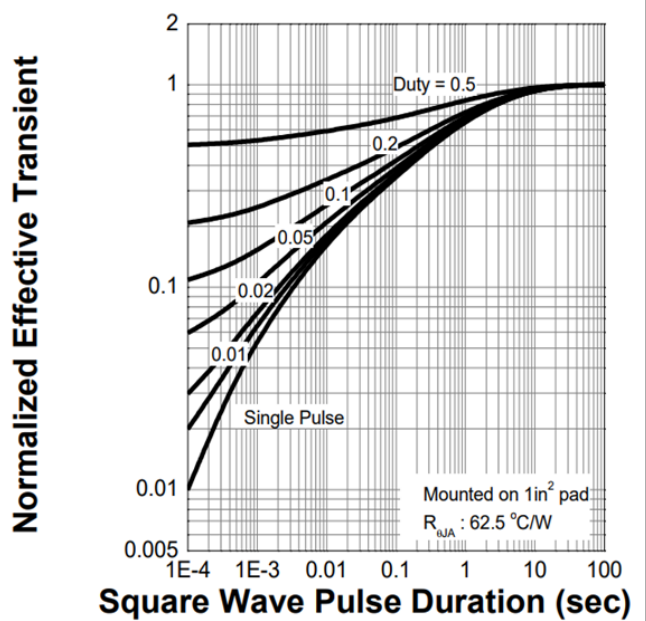

Figure 4. Transient Thermal Impedance

Typical Characteristics

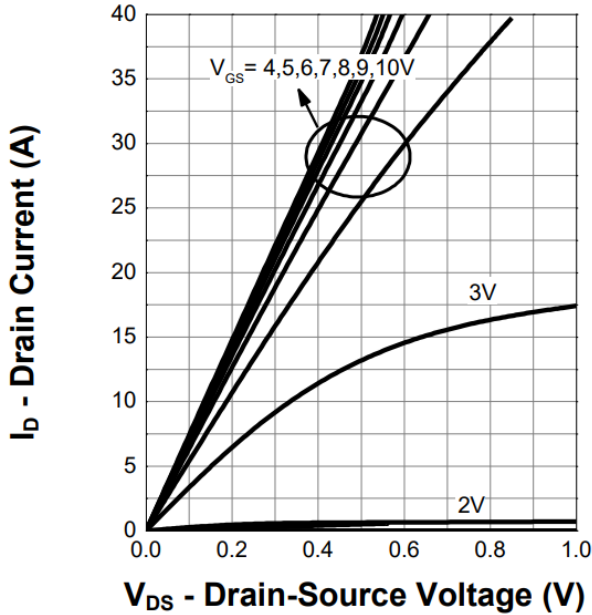

Figure 5. Output Characteristics

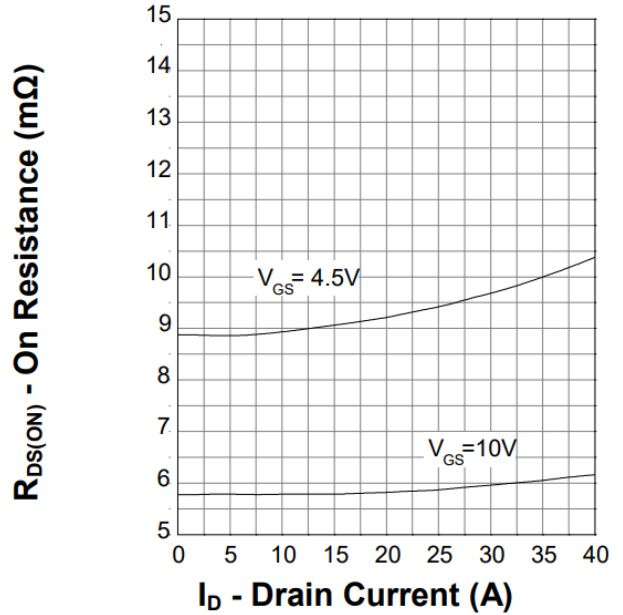

Figure 6. On-Resistance

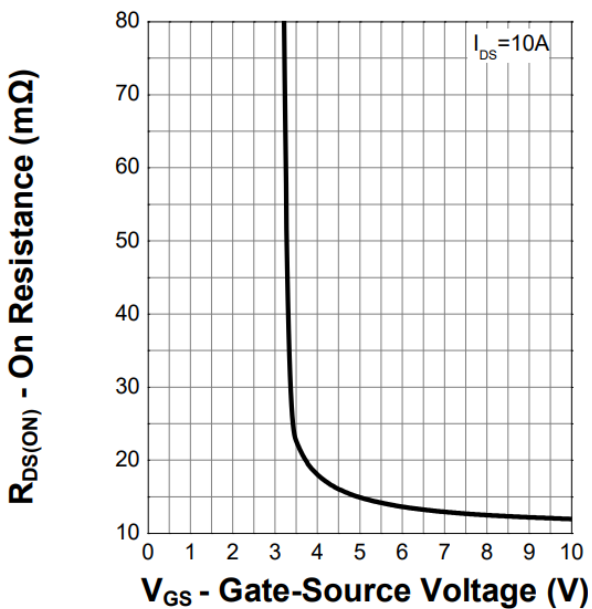

Figure 7. Transfer Characteristics

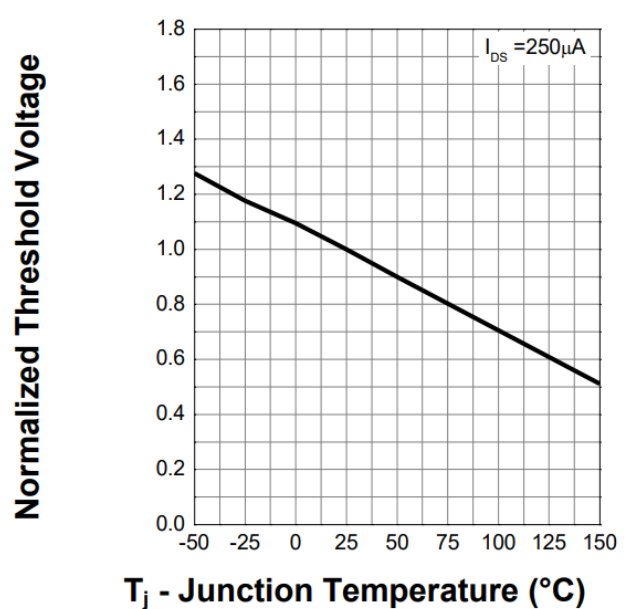

Figure 8. Normalized Threshold Voltage

Typical Characteristics

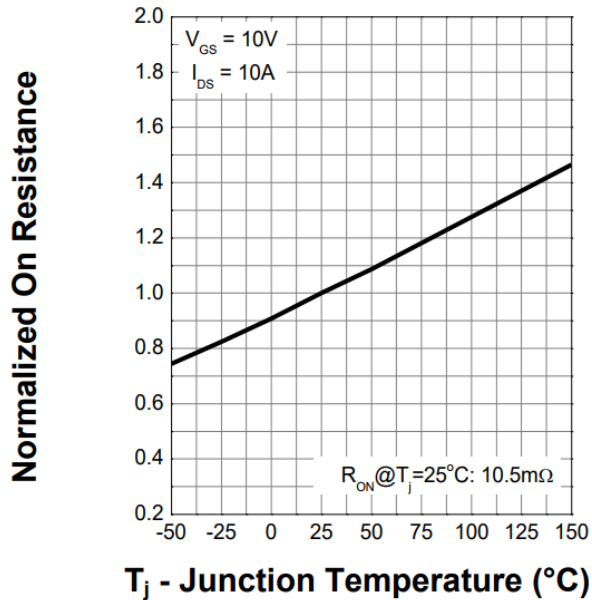

Figure 9. Normalized On-Resistance

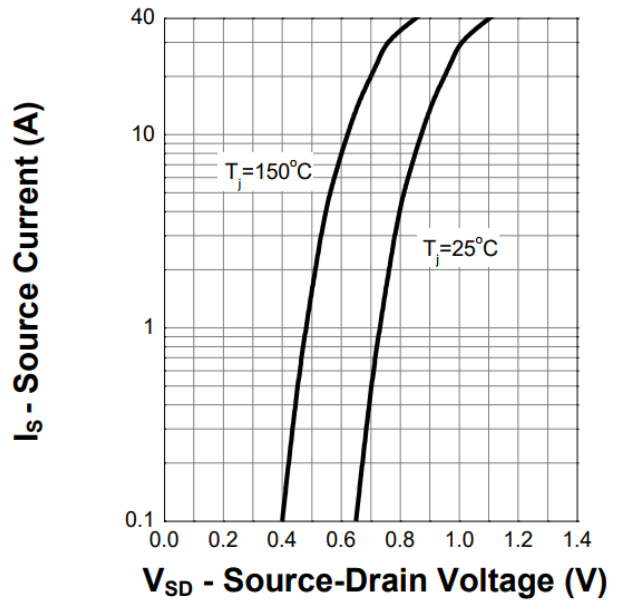

Figure 10. Diode Forward Current

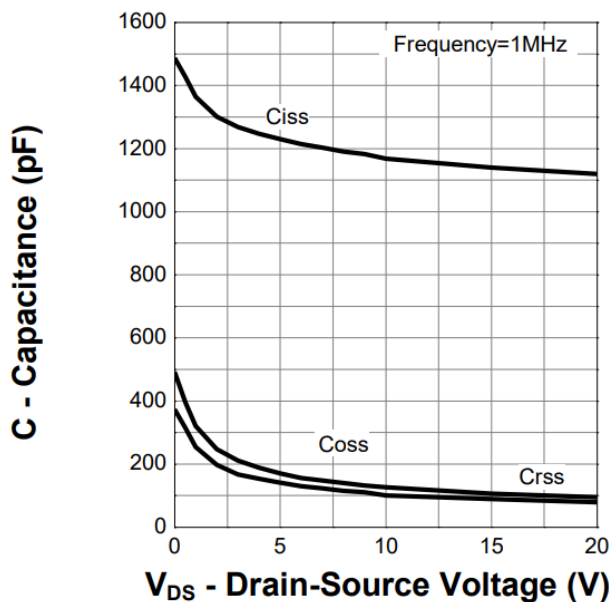

Figure 11. Capacitance

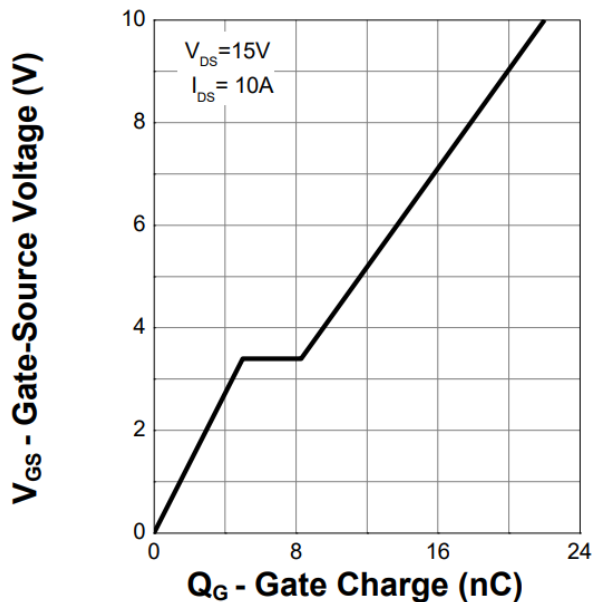
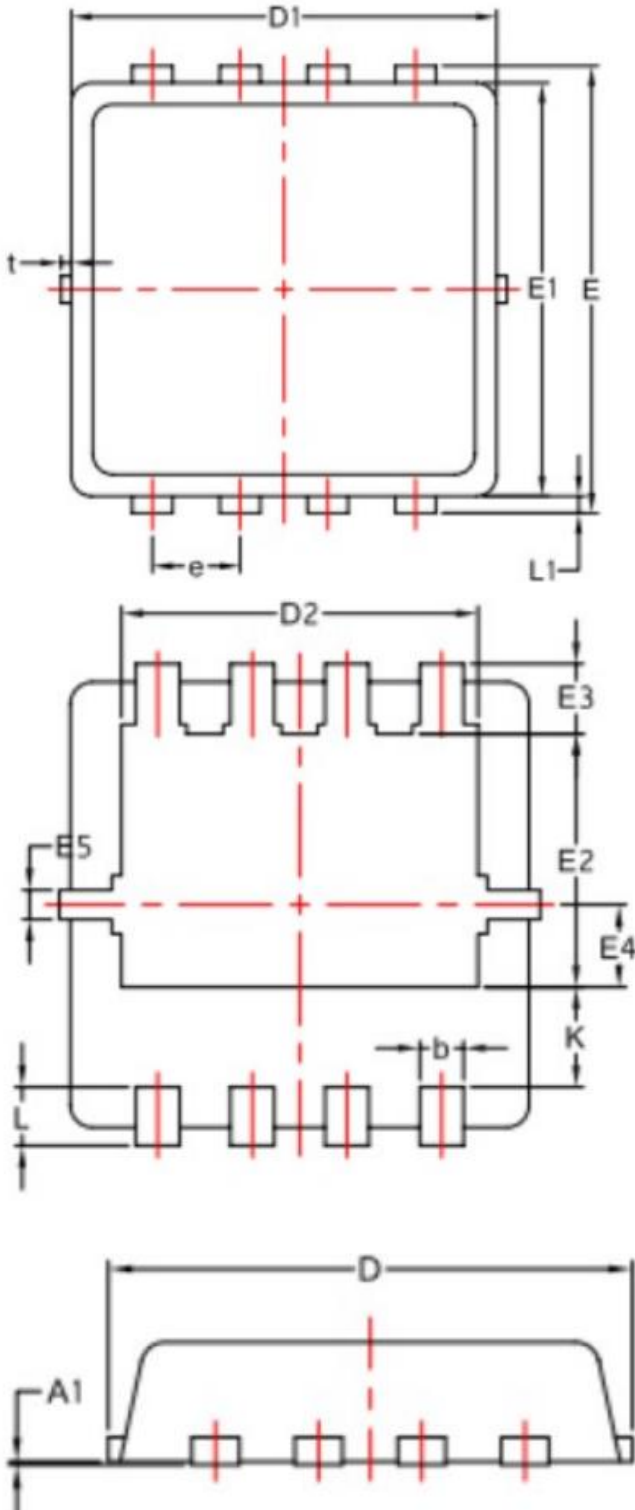

Figure 12. Gate Charge



Package Outline

Unit : mm



SYMBOL	DIMENSION		
	MIN	NOM	MAX
A	0.70	0.75	0.85
A1	-	-	0.05
b	0.20	0.30	0.40
c	0.10	0.152	0.25
D	3.15	3.30	3.45
D1	3.00	3.15	3.25
D2	2.29	2.45	2.65
E	3.15	3.30	3.45
E1	2.90	3.05	3.20
E2	1.54	1.74	1.94
E3	0.28	0.48	0.65
E4	0.37	0.57	0.77
E5	0.10	0.20	0.30
e	0.60	0.65	0.70
K	0.59	0.69	0.89
L	0.30	0.40	0.50
L1	0.06	0.125	0.20
t	0	0.075	0.13
θ	10°	12°	14°

