

# PGT780P030Q

-30V -40A 7.8mΩ Si P-channel Enhancement Mode Split gate MOSFET

## Features

### Si P channel Enhancement Mode Split gate MOSFET

- Rated to -30V at -40Amps @ $T_C = 25^\circ\text{C}$
- Max  $R_{DS(on)} = 8.8\text{ m}\Omega$
- Gate Charge(Typ.  $Q_G=59\text{ nC}$ )
- Advanced Trench Cell Design
- Low thermal Resistance

## Application

- DC-DC Converter
- Motor Drivers

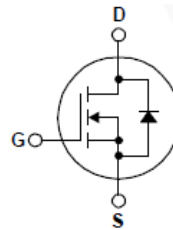
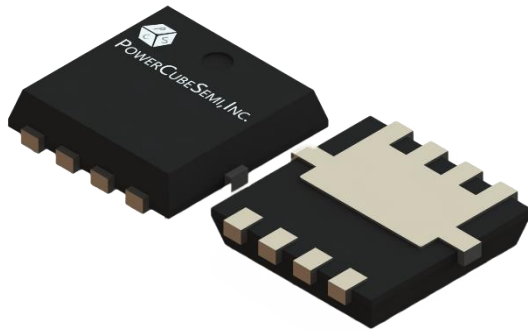

PKG type : PDFN3333

## Absolute Maximum Ratings

$T_C=25^\circ\text{C}$  Unless Otherwise Noted

Symbol	Parameter	Test Condition	Value	Unit
$BV_{DSS}$	Drain-Source Breakdown Voltage	$V_{GS}=0V, I_D=-250\mu A$	-30	V
$I_D^*$	Drain Current	$V_{GS}=-10V, T_C=25^\circ\text{C}$	-40	A
$I_{DM}^{*, **, ***}$	Pulsed Drain Current	$V_{GS}=-10V, T_C=25^\circ\text{C}$	-144	A
$V_{GS}$	Gate-Source Voltage	$T_C=25^\circ\text{C}$	$\pm 20$	V
$P_D^*$	Power Dissipation	$T_C=25^\circ\text{C}$	20	W
$T_J$	Junction Temperature		150	$^\circ\text{C}$
$T_{stg}$	Storage Temperature		-55 to 150	$^\circ\text{C}$
$R_{\theta JC}^*$	Thermal Resistance – Junction to Case		6	$^\circ\text{C/W}$

### Note :

\* Surface Mounted on 1 in<sup>2</sup> pad area,  $t \leq 10\text{ sec}$

\*\* Pulse Width  $\leq 10\mu\text{s}$ , duty cycle  $\leq 1\%$

\*\*\* Limited by bonding wire.

## Electrical Characteristics $T_C=25^\circ\text{C}$ Unless Otherwise Noted

### Static Characteristics

Symbol	Parameter	Test Condition	Numerical			Unit
			Min	Typ.	Max.	
$BV_{DSS}$	Drain-Source Breakdown Voltage	$V_{GS} = 0V, I_D = -250\mu A$	-30	-	-	V
$V_{GS(th)}$	Gate Threshold Voltage	$V_{DS} = V_{GS}, I_D = -250\mu A$	-1	-	-2	V
$I_{DSS}$	Drain-Source Leakage Current	$V_{DS} = -24V, V_{GS} = 0V$	-	-	-1	$\mu A$
$I_{GSS}$	Gate-Source Leakage Current	$V_{GS} = \pm 20V, V_{DS} = 0V$	-	-	$\pm 100$	nA
$R_{DS(ON)}$	Static Drain-Source on state Resistance	$V_{GS} = -10V, I_D = -20A$	-	7.8	8.8	m $\Omega$

### Dynamic Characteristics

Symbol	Parameter	Test Condition	Numerical			Unit
			Min	Typ.	Max.	
$C_{iss}$	Input Capacitance	$V_{GS}=0V, V_{DS}=-15V, f=1\text{MHz}$	-	3651	-	pF
$C_{oss}$	Output Capacitance		-	341	-	
$C_{rss}$	Reverse Transfer Capacitance		-	278	-	
$T_{d(on)}$	Turn-On Delay Time	$V_{DS}=-15V, V_{GEN}=-10V, R_G=4.5\Omega, R_L=0.75\Omega, I_{DS}=-20A$	-	42.8	-	ns
$T_r$	Turn-On Rise Time		-	89	-	
$T_{d(off)}$	Turn-Off Delay Time		-	409	-	
$T_f$	Turn-Off Rise Time		-	193	-	

### Gate Charge Characteristics

Symbol	Parameter	Test Condition	Numerical			Unit
			Min	Typ.	Max.	
$Q_G$	Total Gate Charge	$V_{DS}=-15V, V_{GS}=-10V, I_{DS}=-20A$	-	59	-	nC
$Q_{GS}$	Gate-Source Charge		-	13	-	
$Q_{GD}$	Gate-Drain Charge		-	7.7	-	

### Diode Characteristics

Symbol	Parameter	Test Condition	Numerical			Unit
			Min	Typ.	Max.	
$V_{SD}$	Diode Forward Voltage	$I_{SD}=-20A, V_{GS}=0V$	-	-	-1.3	V
$T_{rr}$	Reverse Recovery Time	$I_{DS}=-20A, V_{GS}=0V, di_{SD}/dt=100A/\mu s$	-	21	-	ns
$Q_{rr}$	Reverse Recovery Charge		-	14	-	nC

## Package Marking and Ordering Information

Device Marking	Device	Package	Packing Method	Tape width	Quantity
PGT780P030Q	PGT780P030	PDFN3333			5000 Unit

## Pin Description

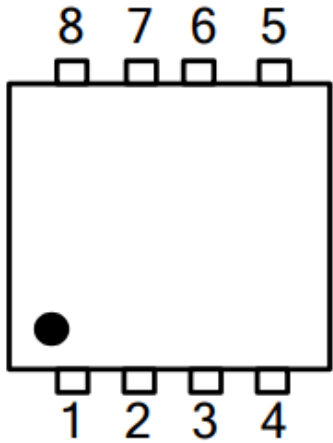
Pin	Description	Simplified Outline
1, 2, 3	Source (S)	
4	Gate (G)	
5, 6, 7, 8	Drain (D)	

# Typical Characteristics

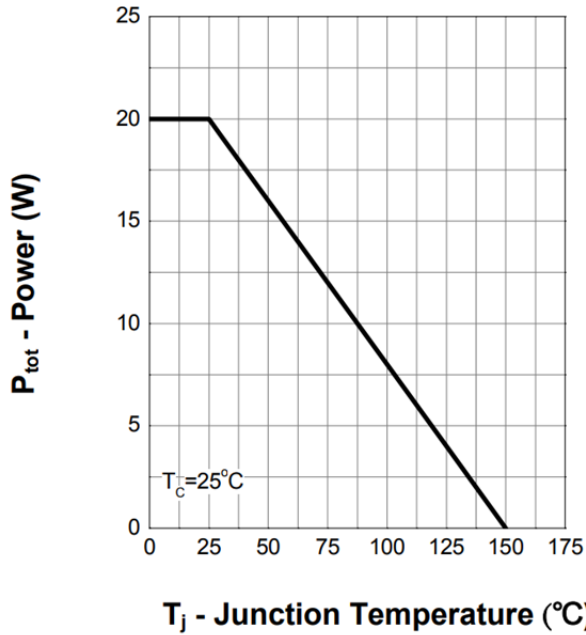

Figure 1. Power Capability

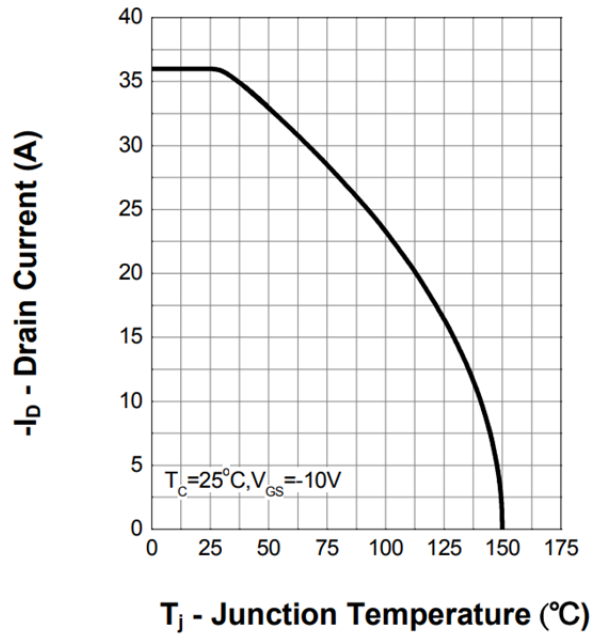

Figure 2. Current Capability

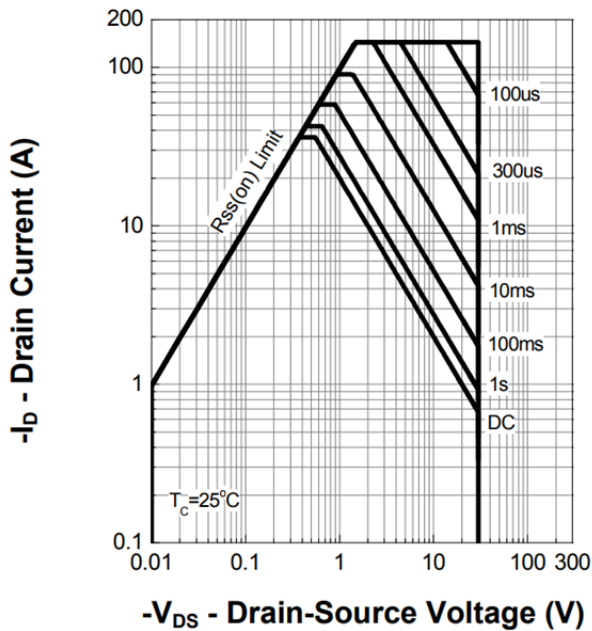

Figure 3. Safe Operating Area

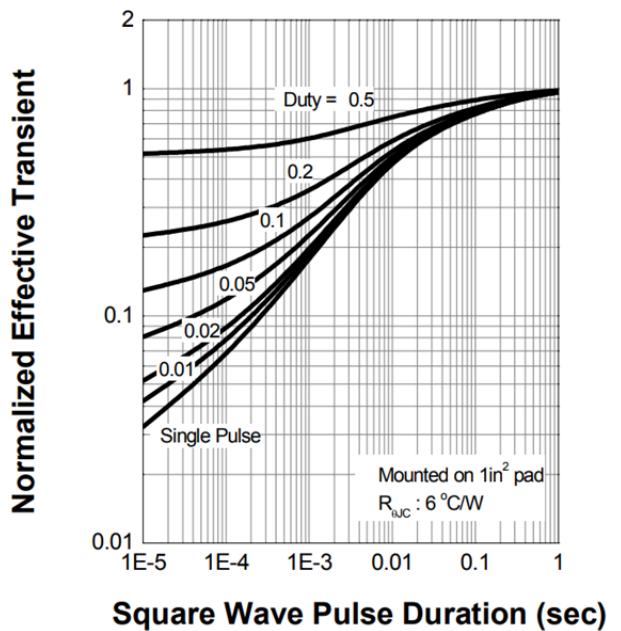

Figure 4. Transient Thermal Impedance

# Typical Characteristics

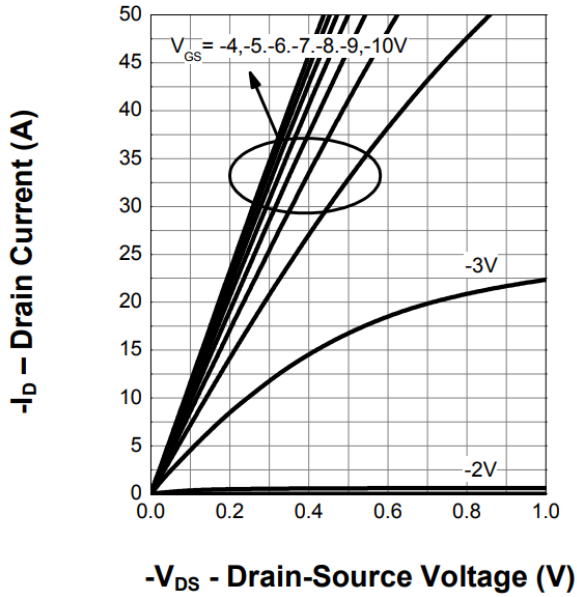

Figure 5. Output Characteristics

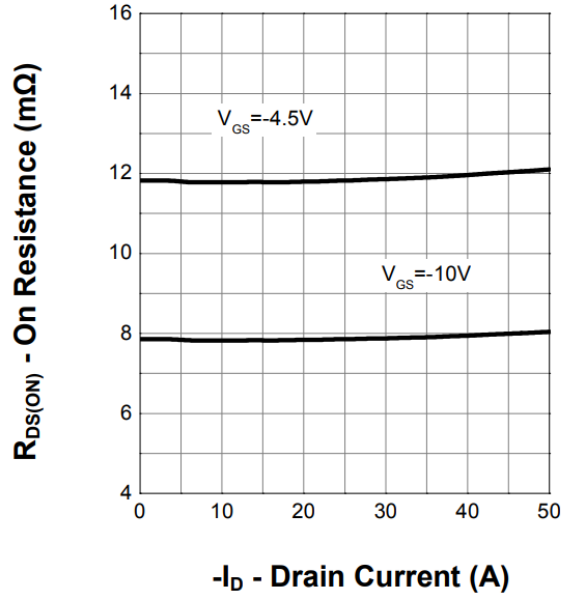

Figure 6. On-Resistance

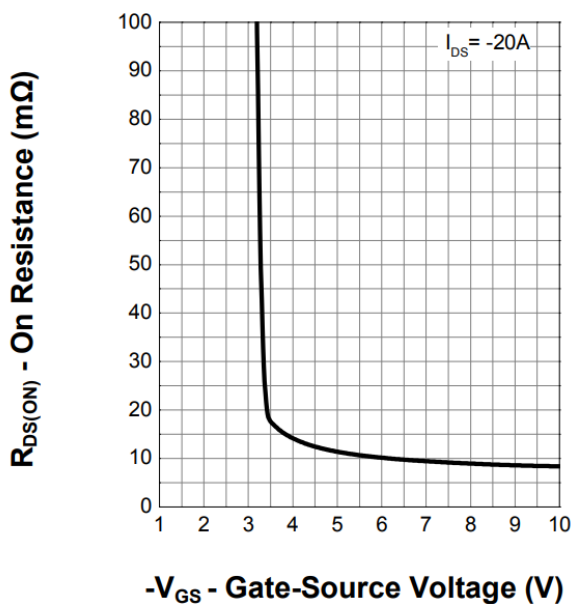

Figure 7. Transfer Characteristics

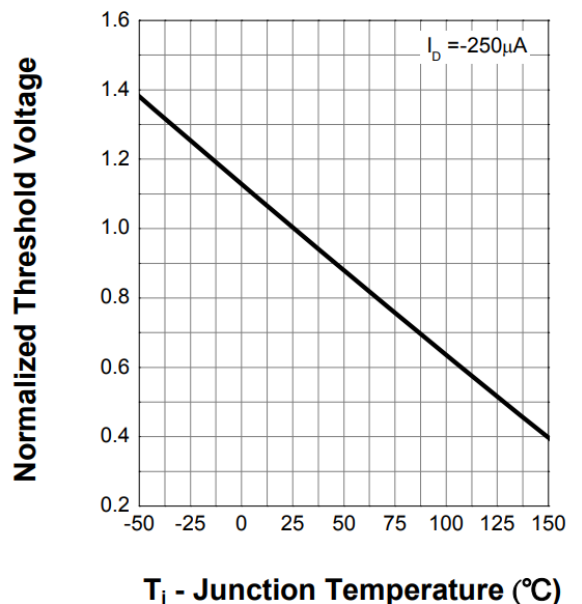

Figure 8. Normalized Threshold Voltage

# Typical Characteristics

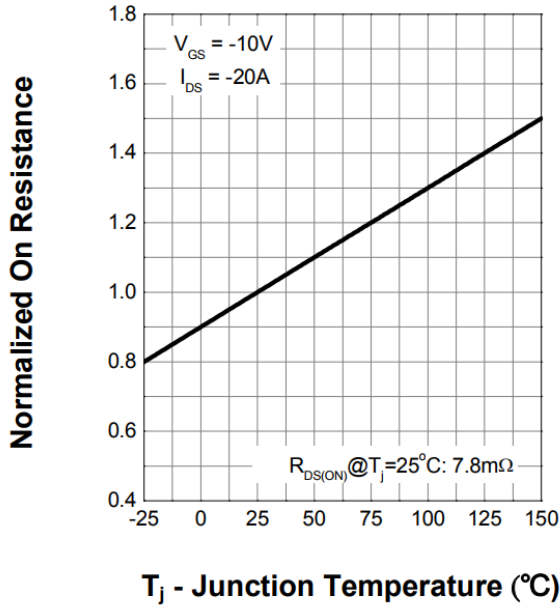

Figure 9. Normalized On-Resistance

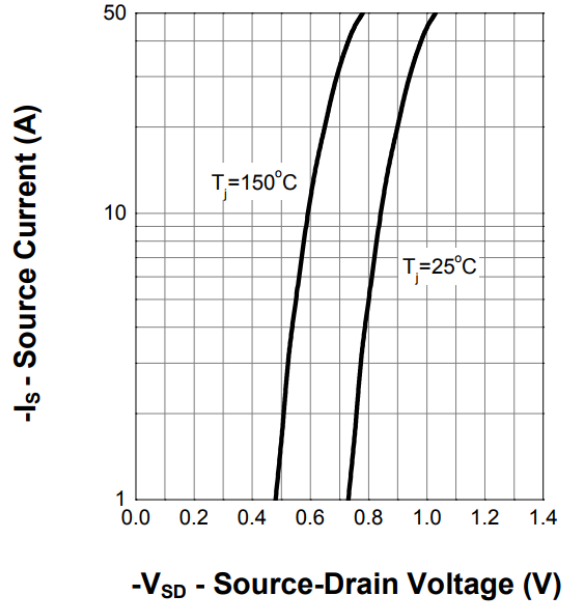

Figure 10. Diode Forward Current

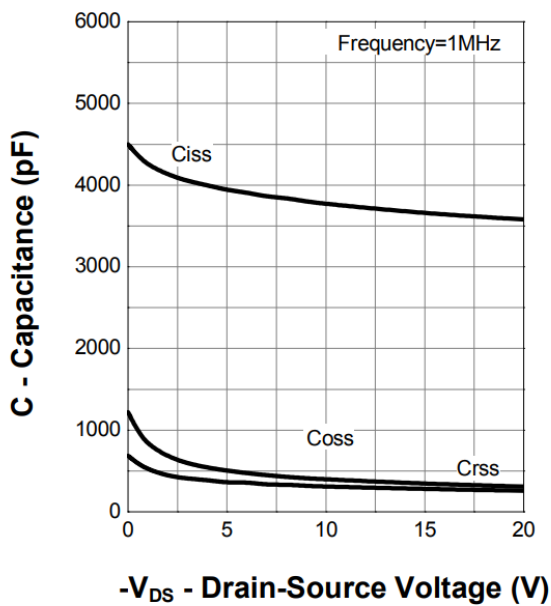

Figure 11. Capacitance

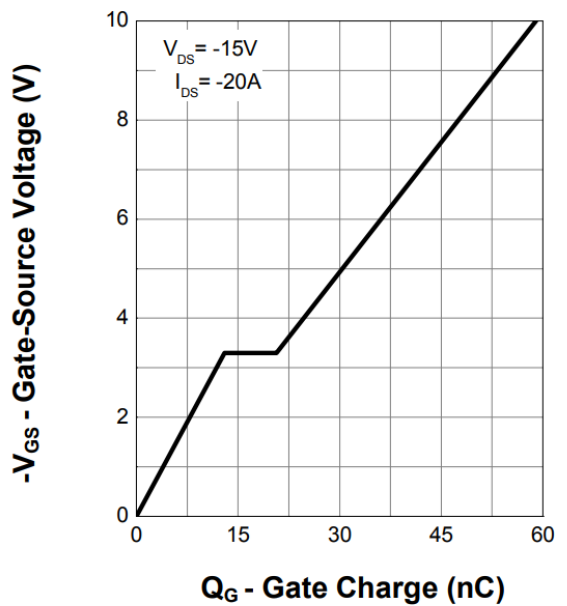
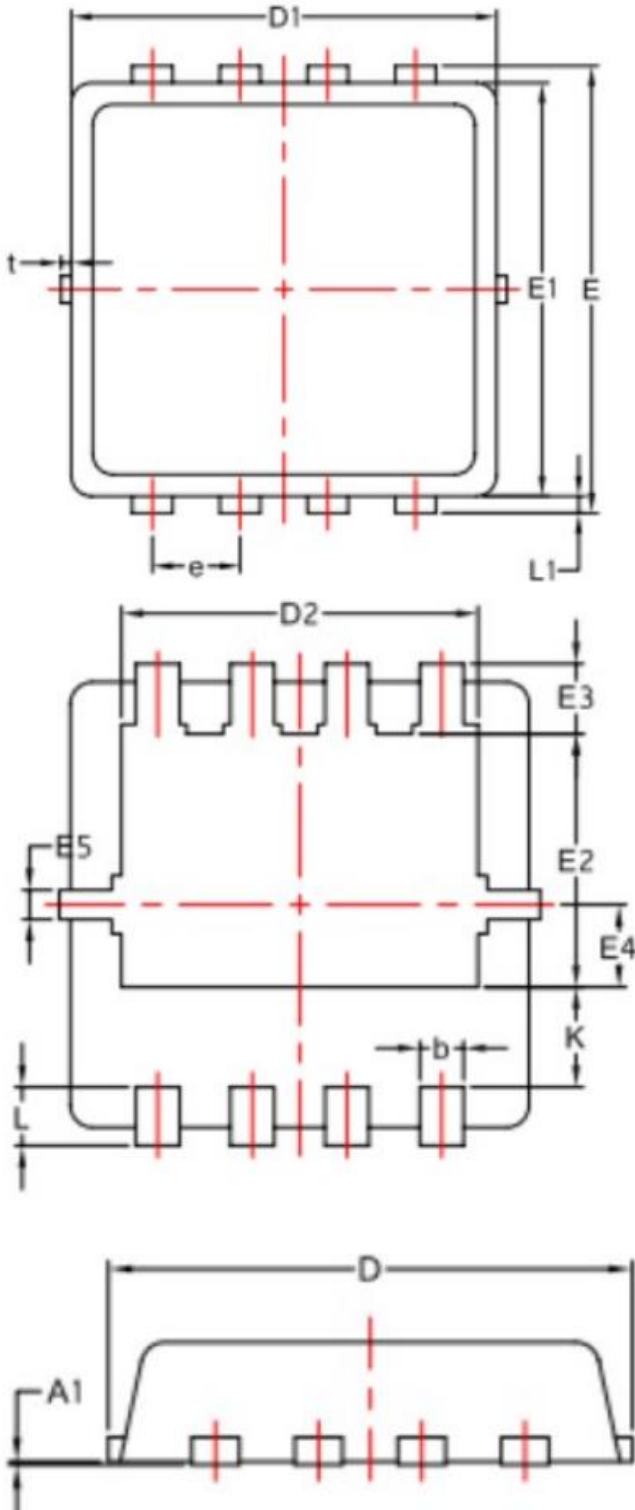

Figure 12. Gate Charge



**Package Outline**

Unit : mm



SYMBOL	DIMENSION		
	MIN	NOM	MAX
A	0.70	0.75	0.85
A1	-	-	0.05
b	0.20	0.30	0.40
c	0.10	0.152	0.25
D	3.15	3.30	3.45
D1	3.00	3.15	3.25
D2	2.29	2.45	2.65
E	3.15	3.30	3.45
E1	2.90	3.05	3.20
E2	1.54	1.74	1.94
E3	0.28	0.48	0.65
E4	0.37	0.57	0.77
E5	0.10	0.20	0.30
e	0.60	0.65	0.70
K	0.59	0.69	0.89
L	0.30	0.40	0.50
L1	0.06	0.125	0.20
t	0	0.075	0.13
θ	10°	12°	14°

