

# PCM050R065EY

## 650V 60A 50mΩ Silicon Carbide MOSFET

### Features

- High-Speed Switching
- Essentially no switching losses
- Reduction of heat sink requirements
- Maximum working temperature at 175°C
- High blocking voltage
- Fast Intrinsic diode with low recovery current
- High-frequency operation

### Applications

- Power factor correction, PFC
- Solar inverter
- Uninterruptible power supply, UPS
- Motor drives
- Photovoltaic inverter
- Electric car and charger

### Package Outline

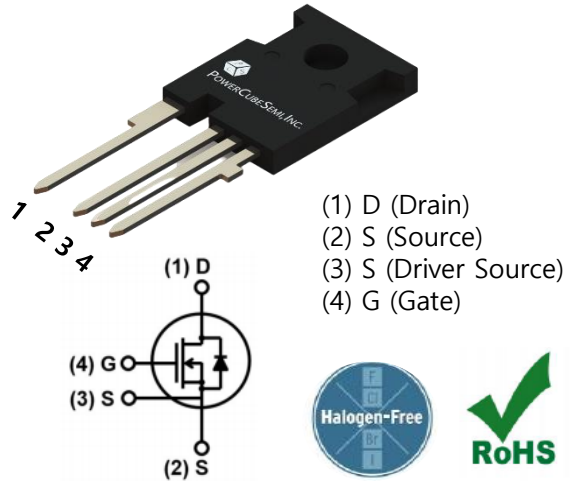

### Absolute Maximum Ratings

$T_j = 25^\circ\text{C}$  unless otherwise noted

Symbol	Parameter	Value	Units
$V_{DSS}$	Drain-Source Voltage	650	V
$I_D$	Drain Current - Continuous ( $T_j = 25^\circ\text{C}$ ) - Continuous ( $T_j = 110^\circ\text{C}$ )	60	A
		41	A
$I_{DM}$	Drain Current - Pulsed	127	A
$V_{GSS\ Max}$	Gate-Source Voltage	-10 / +25	V
$V_{GSS}$	Gate-Source Voltage (Recommended operational)	-5 / +20	V
$E_{AS}$	Avalanche energy, Single pulse	1600	mJ
$P_D$	Power Dissipation ( $T_j = 25^\circ\text{C}$ )	250	W
$T_J, T_{STG}$	Operating and Storage Temperature Range	-55 to +175	$^\circ\text{C}$

### Thermal Characteristics

Symbol	Parameter	Value			Units
		Min	Typ	Max	
$R_{\theta JC}$	Thermal Resistance, Junction-to-Case	-	0.6	-	$^\circ\text{C/W}$

## Electrical Characteristics

**Static Electrical Characteristics**  $T_j = 25^\circ\text{C}$  unless otherwise noted

Symbol	Parameter	Test Conditions	Min	Typ	Max	Units
$BV_{DSS}$	Drain-Source Breakdown Voltage	$V_{GS} = 0\text{ V}, I_D = 100\ \mu\text{A}$	650	-	-	V
$I_{DSS}$	Zero Gate Voltage Drain Current	$V_{DS} = 650\text{ V}, V_{GS} = 0\text{ V}$	-	1	100	$\mu\text{A}$
		$V_{DS} = 650\text{ V}, V_{GS} = 0\text{ V}, T_J = 175^\circ\text{C}$	-	10	500	
$I_{GSS}$	Gate-Source Leakage Current	$V_{GS} = 20\text{ V}, V_{DS} = 0\text{ V}$	-	-	250	nA
$V_{GS(th)}$	Gate Threshold Voltage	$V_{DS} = V_{GS}, I_D = 20\text{ mA}$	-	2.6	-	V
$R_{DS(on)}$	Drain-Source On-Resistance	$V_{GS} = 20\text{ V}, I_D = 20\text{ A}$	-	50	65	m $\Omega$
		$V_{GS} = 20\text{ V}, I_D = 20\text{ A}, T_J = 175^\circ\text{C}$	-	65	-	
$g_{fs}$	Transconductance	$V_{DS} = 15\text{ V}, I_D = 40\text{ A}$	-	13.2	-	S

## Dynamic Characteristics

Symbol	Parameter	Test Conditions	Min	Typ	Max	Units
$C_{iss}$	Input Capacitance	$V_{DS} = 400\text{ V}, V_{GS} = 0\text{ V}, f = 1\text{ MHz}$	-	1850	-	pF
$C_{oss}$	Output Capacitance		-	208	-	
$C_{riss}$	Reverse Transfer Capacitance		-	33	-	
$E_{oss}$	Coss stored energy		-	24	-	$\mu\text{J}$
$Q_g$	Total Gate Charge	$V_{DS} = 400\text{ V}, I_D = 30\text{ A}, V_{GS} = -5 / 20\text{ V}$	-	30	-	nC
$Q_{gs}$	Gate-Source Charge		-	43	-	
$Q_{gd}$	Gate-Drain Charge		-	121	-	
$R_G$	Internal Gate Resistance	$f = 1\text{ MHz}, V_{AC} = 25\text{ mV}$	-	1.2	-	$\Omega$

## Electrical Characteristics

### Switching Characteristics

$T_j = 25^\circ\text{C}$  unless otherwise noted

Symbol	Parameter	Test Conditions	Min	Typ	Max	Units
$t_{d(on)}$	Turn-On Delay Time	$V_{DD} = 400\text{V}, V_{GS} = -4/20\text{V},$ $I_D = 20\text{A}, R_L = 20\Omega,$ $R_G = 2.7\Omega$	-	16	-	ns
$t_r$	Turn-On Rise Time		-	17	-	
$t_{d(off)}$	Turn-Off Delay Time		-	20	-	
$t_f$	Turn-Off Fall Time		-	10	-	
$E_{on}$	Turn-On Switching loss	$V_{DD} = 400\text{V}, V_{GS} = 0/20\text{V},$ $I_D = 50\text{A}, R_G = 2.7\Omega$	-	21	-	uJ
$E_{off}$	Turn-Off Switching loss		-	28	-	

### Body Diode Characteristics

Symbol	Parameter	Test Conditions	Min	Typ	Max	Units
$I_S$	Maximum Continuous Diode Forward Current	$V_{GS} = 0\text{V}, T_j = 25^\circ\text{C}$	-	42.5	-	A
$I_{SM}$	Maximum Pulsed Diode Forward Current		-	127	-	
$V_{SD}$	Diode Forward Voltage	$V_{GS} = 0\text{V}, I_{SD} = 5\text{A}$	-	3.0	-	V
$T_{rr}$	Reverse Recovery Time	$V_R = 400\text{V}, V_{GS} = 0\text{V},$ $I_S = 30\text{A}, dI_F / dt = 300\text{A}/\mu\text{s}$	-	58	-	ns
$Q_{rr}$	Reverse Recovery Charge		-	122	-	nC
$I_{rr}$	Reverse Recovery Current		-	3.75	-	A

# Typical Characteristics

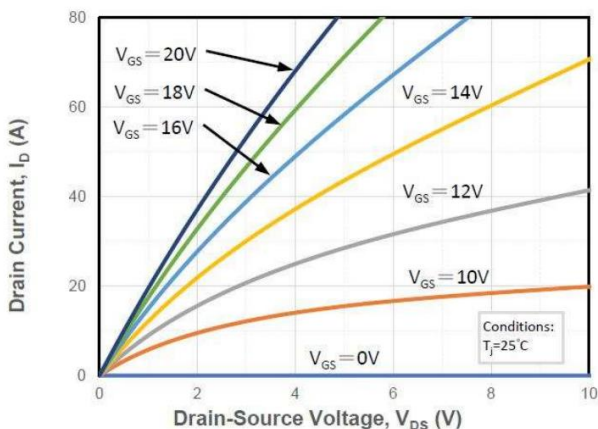

Figure 1. Output Characteristics at  $T_j=25^\circ\text{C}$

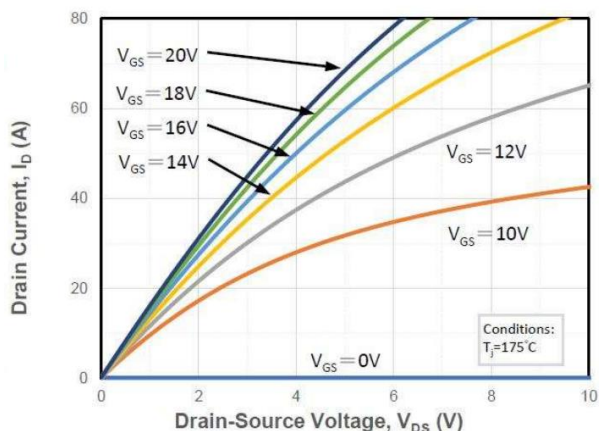

Figure 2. Output Characteristics at  $T_j=175^\circ\text{C}$

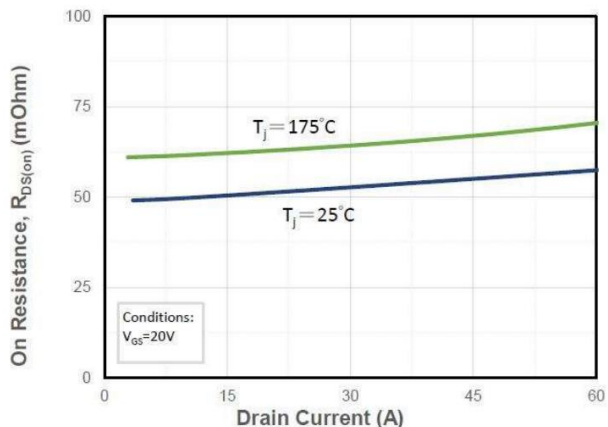

Figure 3. On Resistance vs. Drain Current

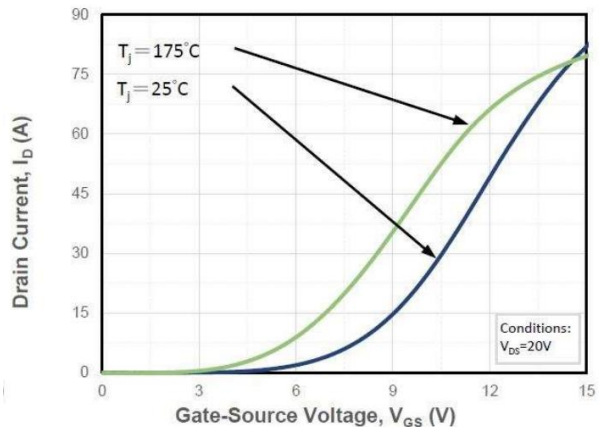

Figure 4. Transfer Characteristics for various  $T_j$

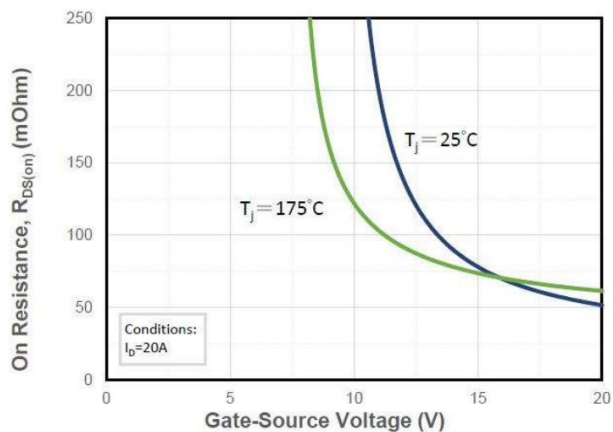

Figure 5. On Resistance vs. gate voltage for various  $T_j$

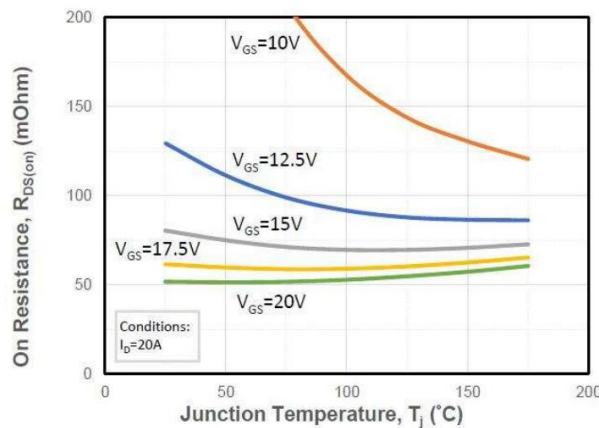

Figure 6. On Resistance vs. Temperature for various gate voltage

## Typical Characteristics

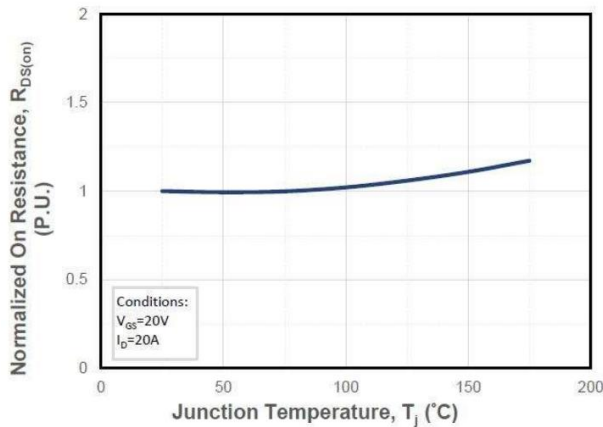

Figure 7. Normalized On Resistance vs. Temperature

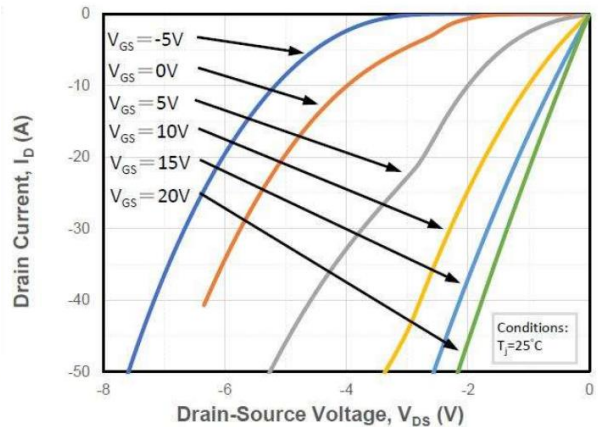

Figure 8. Reverse Output Characteristics at  $T_J=25^\circ\text{C}$

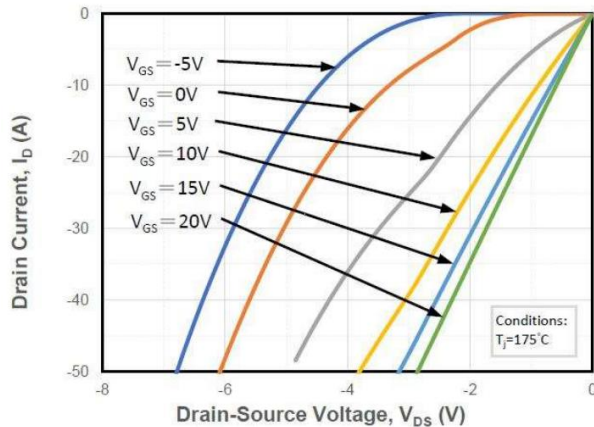

Figure 9. Reverse Output Characteristics at  $T_J=175^\circ\text{C}$

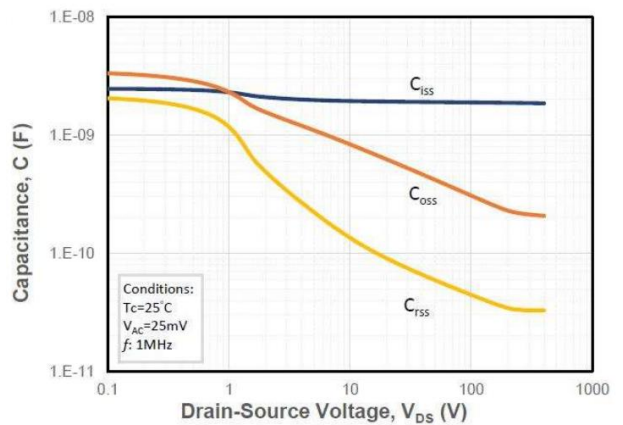

Figure 10. Capacitances vs. Drain to Source Voltage

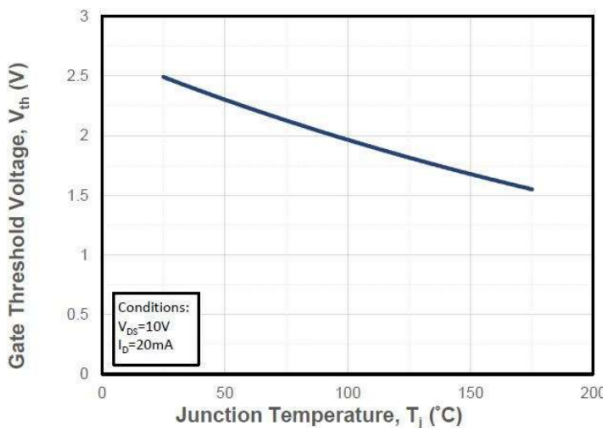

Figure 11. Threshold Voltage vs. Temperature

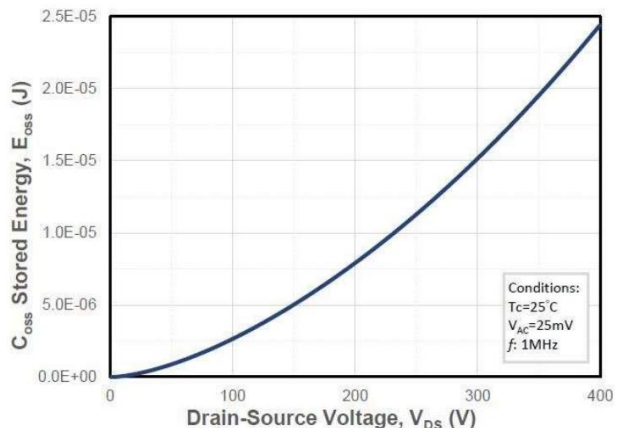

Figure 12. Output Capacitor Stored Energy

## Typical Characteristics

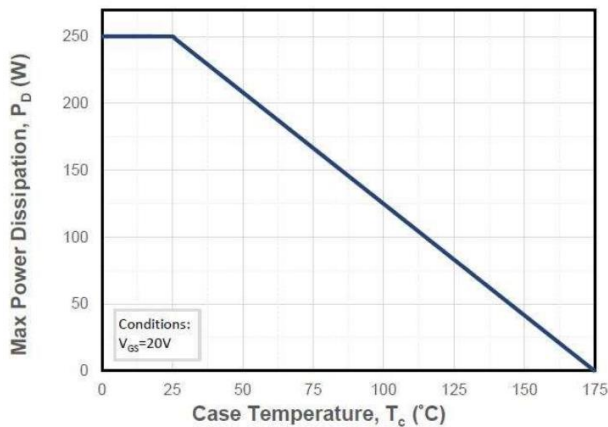

Figure 13. Maximum Power Dissipation Derating vs. Case Temperature

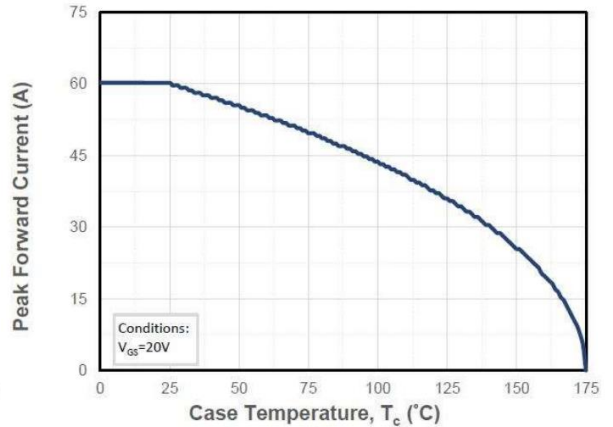

Figure 14. Drain Current Derating vs. Case Temperature

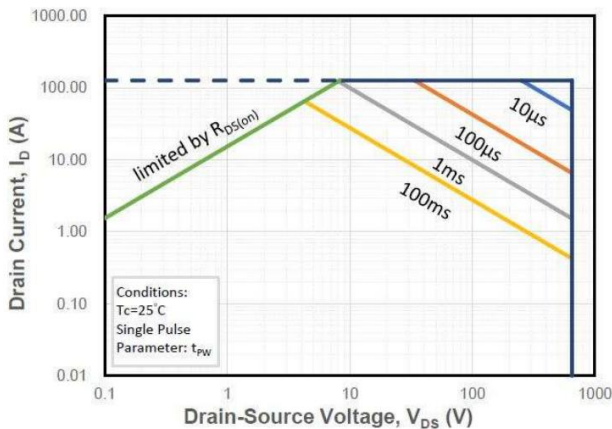

Figure 15. Safe Operating Area

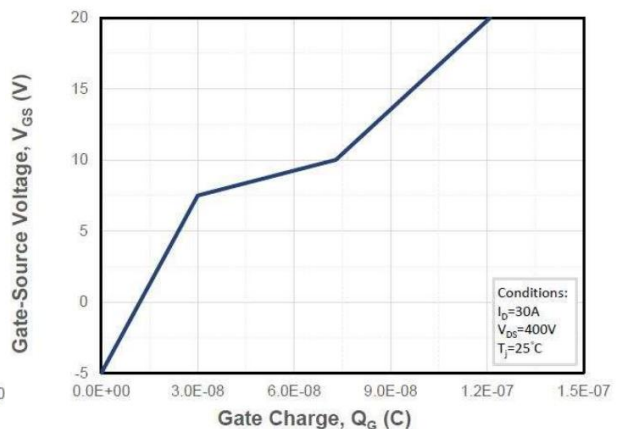

Figure 16. Gate Charge Characteristics

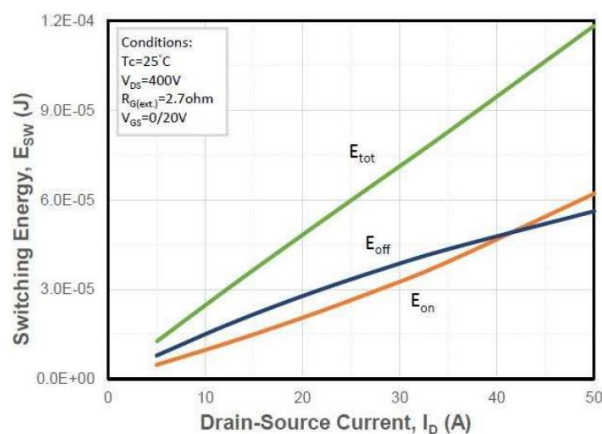

Figure 17. Clamped Inductive Switching Energy vs. Drain Current

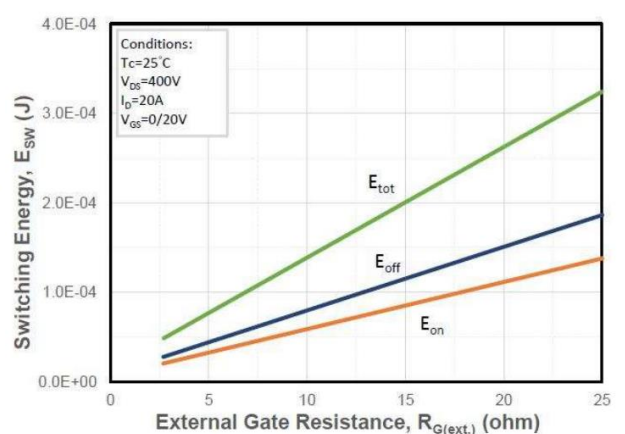

Figure 18. Clamped Inductive Switching Energy vs. External Gate Resistor

## Typical Characteristics

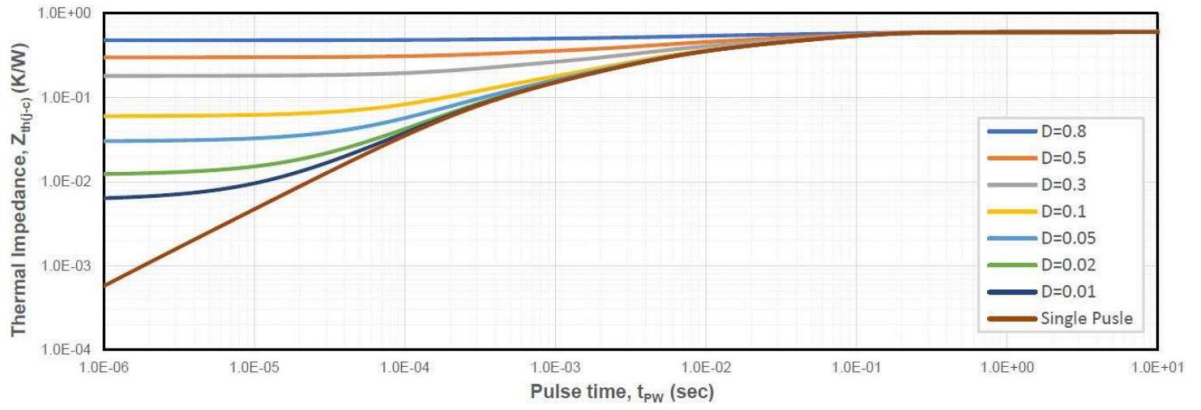
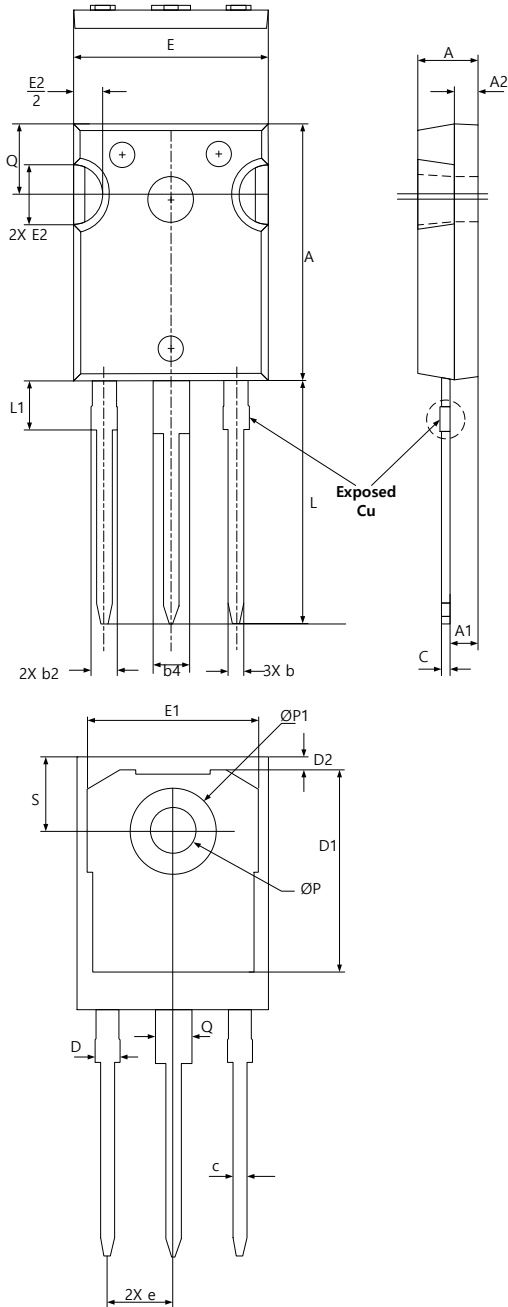

Figure 19. Transient Junction to Case Thermal Impedance

## Package Outline



SYMBOL	DIMENSIONS			NOTES
	MIN	NOM	MAX	
<b>A</b>	4.83	5.02	5.21	
<b>A1</b>	2.29	2.41	2.55	
<b>A2</b>	1.50	2.00	2.49	
<b>b</b>	1.12	1.20	1.33	
<b>b1</b>	1.12	1.20	1.28	
<b>b2</b>	1.91	2.00	2.39	6
<b>b3</b>	1.91	2.00	2.34	
<b>b4</b>	2.87	3.00	3.22	6, 8
<b>b5</b>	2.87	3.00	3.18	
<b>c</b>	0.55	0.60	0.69	6
<b>c1</b>	0.55	6.00	0.65	
<b>D</b>	20.80	20.95	21.10	4
<b>D1</b>	16.25	16.55	17.65	5
<b>D2</b>	0.51	1.19	1.35	
<b>E</b>	15.75	15.94	16.13	4
<b>E1</b>	13.46	14.02	14.16	5
<b>E2</b>	4.32	4.91	5.49	3
<b>e</b>	5.44 BSC			
<b>L</b>	19.81	20.07	20.32	
<b>L1</b>	4.10	4.19	4.40	6
<b><math>\phi P</math></b>	3.56	3.61	3.65	7
<b><math>\phi P1</math></b>	7.19 REF			
<b>Q</b>	5.39	5.79	6.20	
<b>S</b>	6.04	6.17	6.30	