



PCM100R065BY

650V 32A 100mΩ Silicon Carbide MOSFET

Features

- High-Speed Switching
- Essentially no switching losses
- Reduction of heat sink requirements
- Maximum working temperature at 175°C
- High blocking voltage
- Fast Intrinsic diode with low recovery current
- High-frequency operation

Package Outline

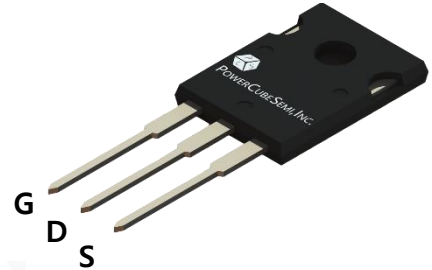

Applications

- Power factor correction, PFC
- Solar inverter
- Uninterruptible power supply, UPS
- Motor drives
- Photovoltaic inverter
- Electric car and charger

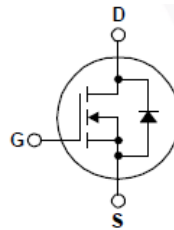

Absolute Maximum Ratings

$T_j = 25^\circ\text{C}$ unless otherwise noted

Symbol	Parameter	Value	Units
V_{DSS}	Drain-Source Voltage	650	V
I_D	Drain Current - Continuous ($T_j = 25^\circ\text{C}$) - Continuous ($T_j = 110^\circ\text{C}$)	32	A
		22	A
I_{DM}	Drain Current - Pulsed	58.5	A
$V_{GSS\ Max}$	Gate-Source Voltage	-10 / +25	V
V_{GSS}	Gate-Source Voltage (Recommended operational)	-5 / +20	V
E_{AS}	Avalanche energy, Single pulse	800	mJ
P_D	Power Dissipation ($T_j = 25^\circ\text{C}$)	166	W
T_J, T_{STG}	Operating and Storage Temperature Range	-55 to +175	$^\circ\text{C}$

Thermal Characteristics

Symbol	Parameter	Value			Units
		Min	Typ	Max	
$R_{\theta JC}$	Thermal Resistance, Junction-to-Case	-	0.9	-	$^\circ\text{C/W}$

Electrical Characteristics

Static Electrical Characteristics $T_j = 25^\circ\text{C}$ unless otherwise noted

Symbol	Parameter	Test Conditions	Min	Typ	Max	Units
BV_{DSS}	Drain-Source Breakdown Voltage	$V_{GS} = 0\text{ V}, I_D = 100\ \mu\text{A}$	650	-	-	V
I_{DSS}	Zero Gate Voltage Drain Current	$V_{DS} = 650\text{ V}, V_{GS} = 0\text{ V}$	-	1	50	μA
		$V_{DS} = 650\text{ V}, V_{GS} = 0\text{ V}, T_J = 175^\circ\text{C}$	-	5	500	
I_{GSS}	Gate-Source Leakage Current	$V_{GS} = 20\text{ V}, V_{DS} = 0\text{ V}$	-	-	250	nA
$V_{GS(th)}$	Gate Threshold Voltage	$V_{DS} = V_{GS}, I_D = 10\text{ mA}$	-	2.6	-	V
$R_{DS(on)}$	Drain-Source On-Resistance	$V_{GS} = 20\text{ V}, I_D = 12\text{ A}$	-	100	130	m Ω
		$V_{GS} = 20\text{ V}, I_D = 12\text{ A}, T_J = 175^\circ\text{C}$	-	130	-	
g_{fs}	Transconductance	$V_{DS} = 15\text{ V}, I_D = 25\text{ A}$	-	8.5	-	S

Dynamic Characteristics

Symbol	Parameter	Test Conditions	Min	Typ	Max	Units
C_{iss}	Input Capacitance	$V_{DS} = 400\text{ V}, V_{GS} = 0\text{ V}, f = 1\text{ MHz}$	-	910	-	pF
C_{oss}	Output Capacitance		-	105	-	
C_{rss}	Reverse Transfer Capacitance		-	13	-	
E_{oss}	Coss stored energy		-	10	-	μJ
Q_g	Total Gate Charge	$V_{DS} = 400\text{ V}, I_D = 12\text{ A}, V_{GS} = -5 / 20\text{ V}$	-	13.5	-	nC
Q_{gs}	Gate-Source Charge		-	34	-	
Q_{gd}	Gate-Drain Charge		-	66	-	
R_G	Internal Gate Resistance	$f = 1\text{ MHz}, V_{AC} = 25\text{ mV}$	-	2	-	Ω

Electrical Characteristics

Switching Characteristics

$T_j = 25^\circ\text{C}$ unless otherwise noted

Symbol	Parameter	Test Conditions	Min	Typ	Max	Units
$t_{d(on)}$	Turn-On Delay Time	$V_{DD} = 400\text{V}, V_{GS} = -4/20\text{V},$ $I_D = 10\text{A}, R_L = 40\Omega,$ $R_G = 8.2\Omega$	-	15	-	ns
t_r	Turn-On Rise Time		-	17	-	
$t_{d(off)}$	Turn-Off Delay Time		-	15	-	
t_f	Turn-Off Fall Time		-	15	-	
E_{on}	Turn-On Switching loss	$V_{DD} = 400\text{V}, V_{GS} = 0/20\text{V},$ $I_D = 12\text{A}, R_G = 2.7\Omega$	-	6.2	-	uJ
E_{off}	Turn-Off Switching loss		-	9.1	-	

Body Diode Characteristics

Symbol	Parameter	Test Conditions	Min	Typ	Max	Units
I_S	Maximum Continuous Diode Forward Current	$V_{GS} = 0\text{V}, T_j = 25^\circ\text{C}$	-	26.5	-	A
I_{SM}	Maximum Pulsed Diode Forward Current		-	58.5	-	
V_{SD}	Diode Forward Voltage	$V_{GS} = 0\text{V}, I_{SD} = 3\text{A}$	-	3.3	-	V
T_{rr}	Reverse Recovery Time	$V_R = 400\text{V}, V_{GS} = 0\text{V},$ $I_S = 12\text{A}, dI_F / dt = 300\text{A/us}$	-	54	-	ns
Q_{rr}	Reverse Recovery Charge		-	72	-	nC
I_{rr}	Reverse Recovery Current		-	2.57	-	A

Typical Characteristics

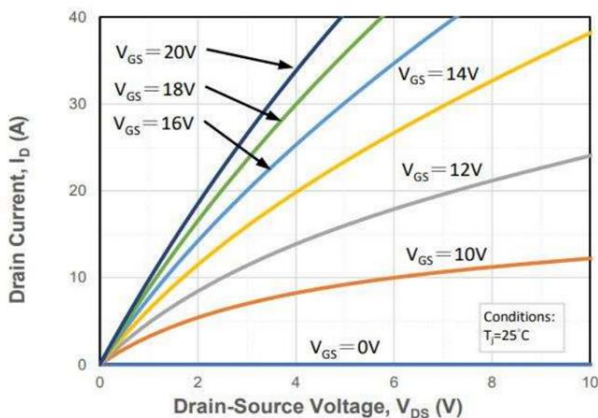

Figure 1. Output Characteristics at $T_j=25\text{ }^\circ\text{C}$

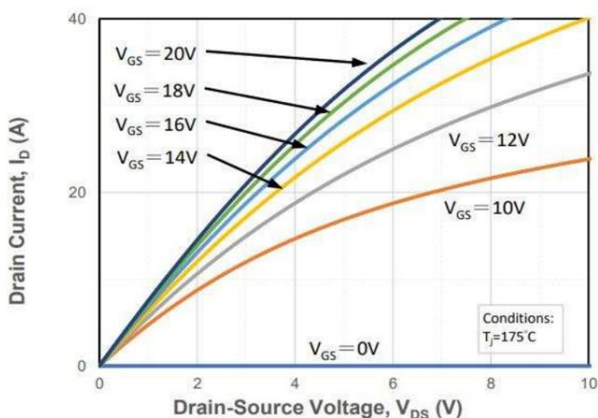

Figure 2. Output Characteristics at $T_j=175\text{ }^\circ\text{C}$

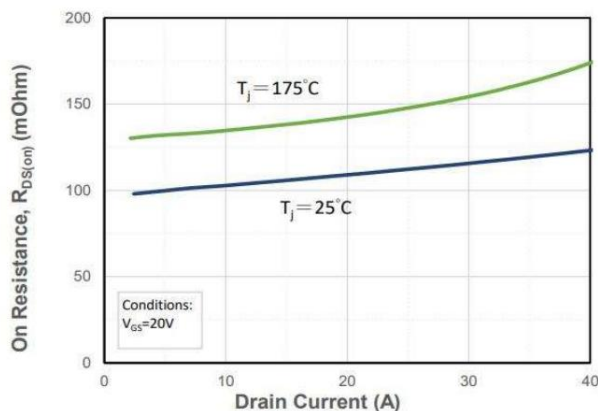

Figure 3. On Resistance vs. Drain Current

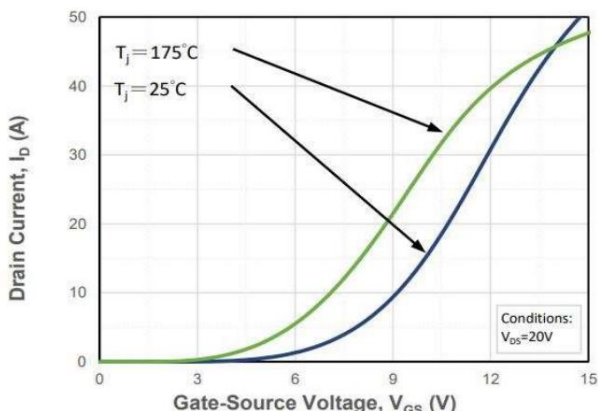

Figure 4. Transfer Characteristics for various T_j

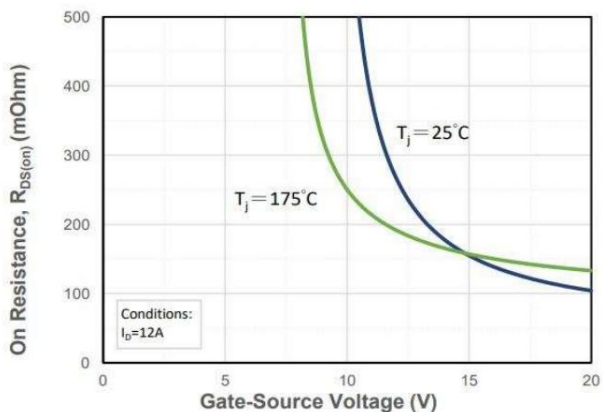

Figure 5. On Resistance vs. gate voltage for various T_j

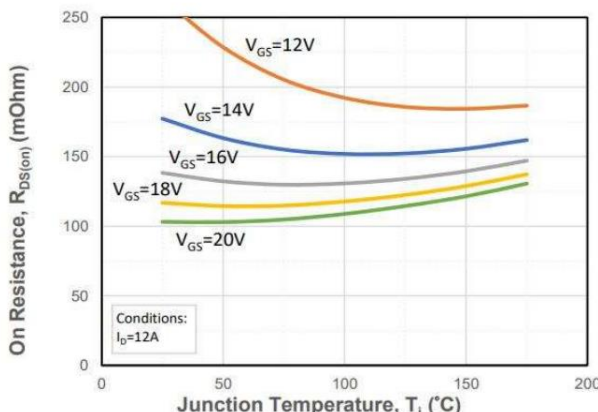

Figure 6. On Resistance vs. Temperature for various gate voltage

Typical Characteristics

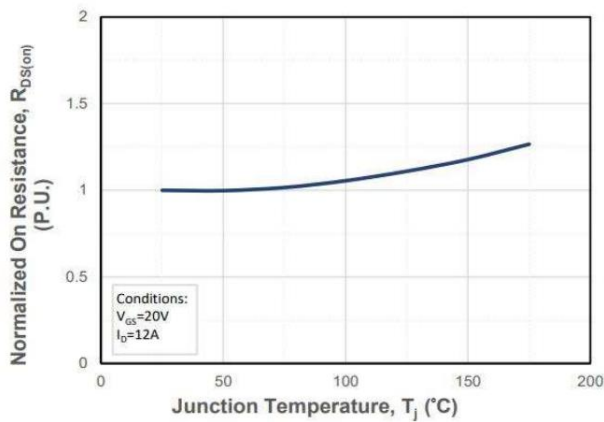

Figure 7. Normalized On Resistance vs. Temperature

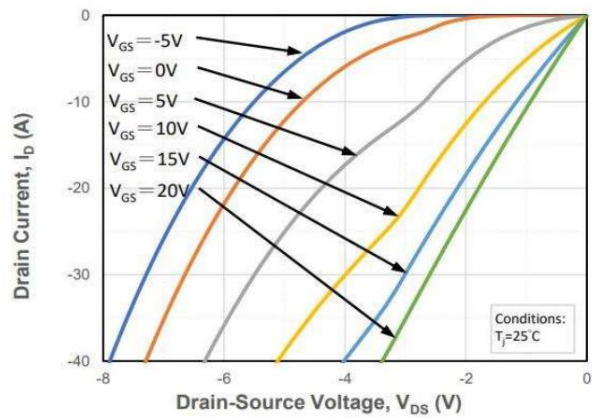

Figure 8. Reverse Output Characteristics at $T_J=25^\circ\text{C}$

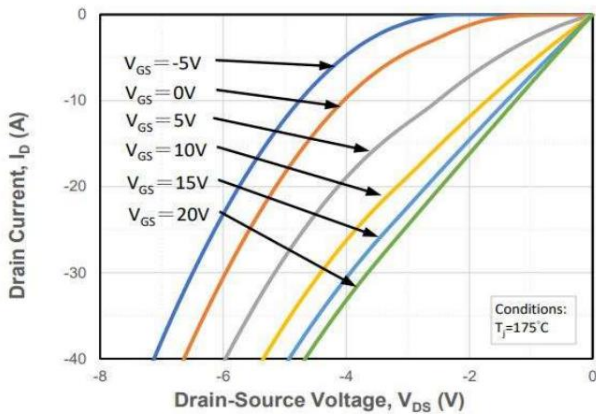

Figure 9. Reverse Output Characteristics at $T_J=175^\circ\text{C}$

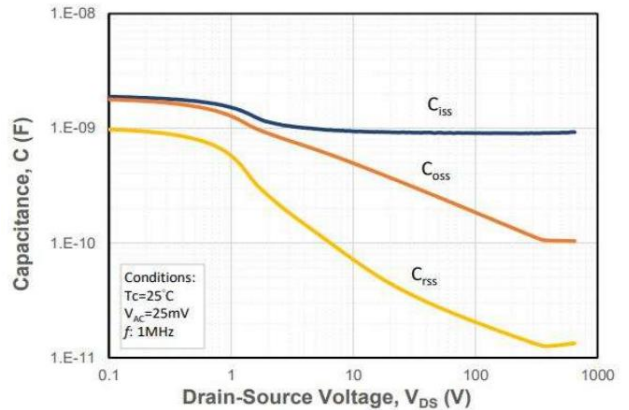

Figure 10. Capacitances vs. Drain to Source Voltage

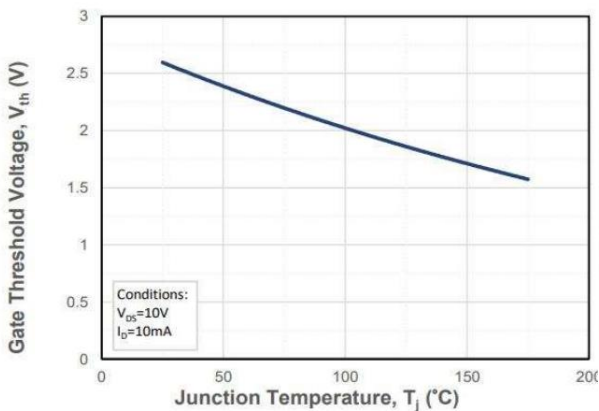

Figure 11. Threshold Voltage vs. Temperature

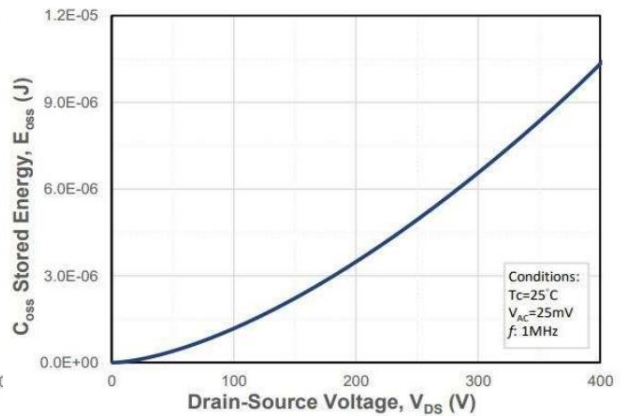

Figure 12. Output Capacitor Stored Energy

Typical Characteristics

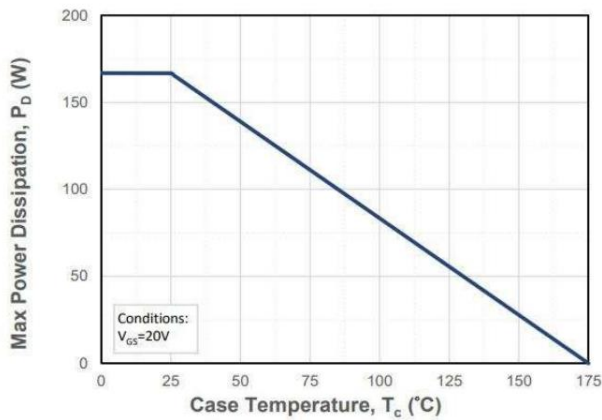

Figure 13. Maximum Power Dissipation Derating vs. Case Temperature

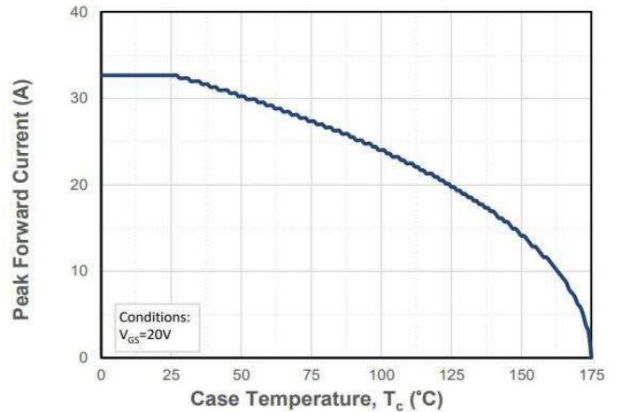

Figure 14. Drain Current Derating vs. Case Temperature

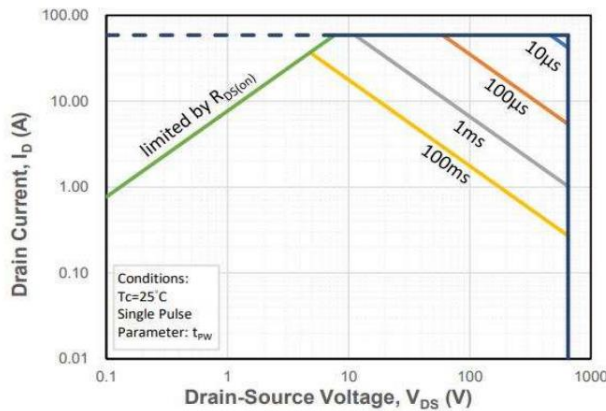

Figure 15. Safe Operating Area

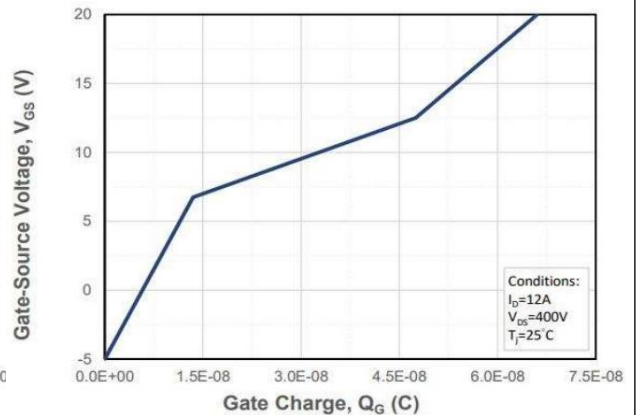

Figure 16. Gate Charge Characteristics

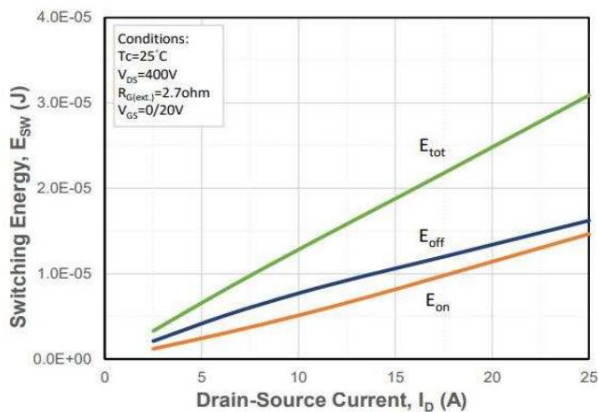

Figure 17. Clamped Inductive Switching Energy vs. Drain Current

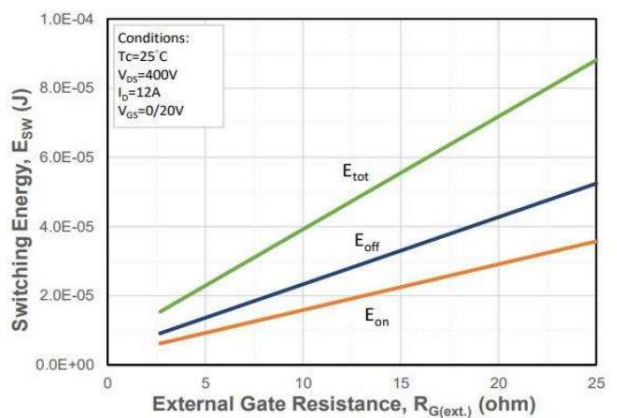

Figure 18. Clamped Inductive Switching Energy vs. External Gate Resistor

Typical Characteristics

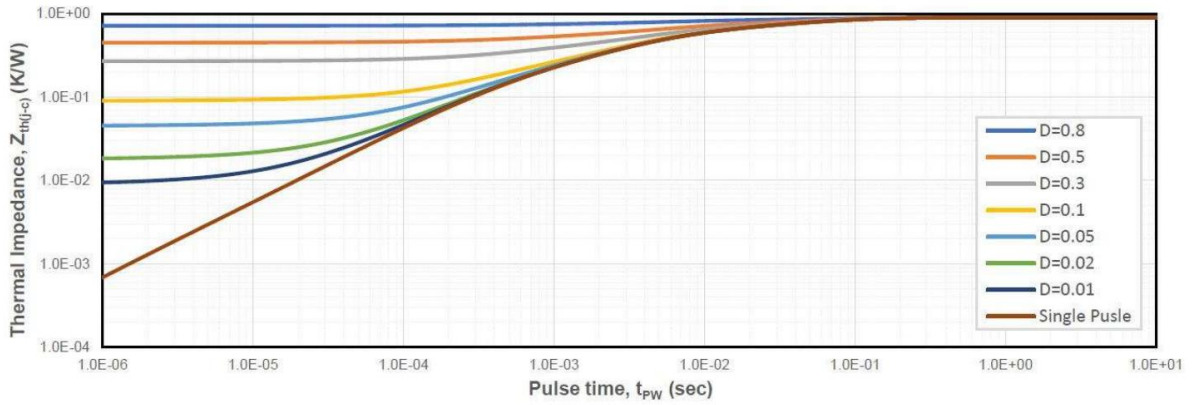
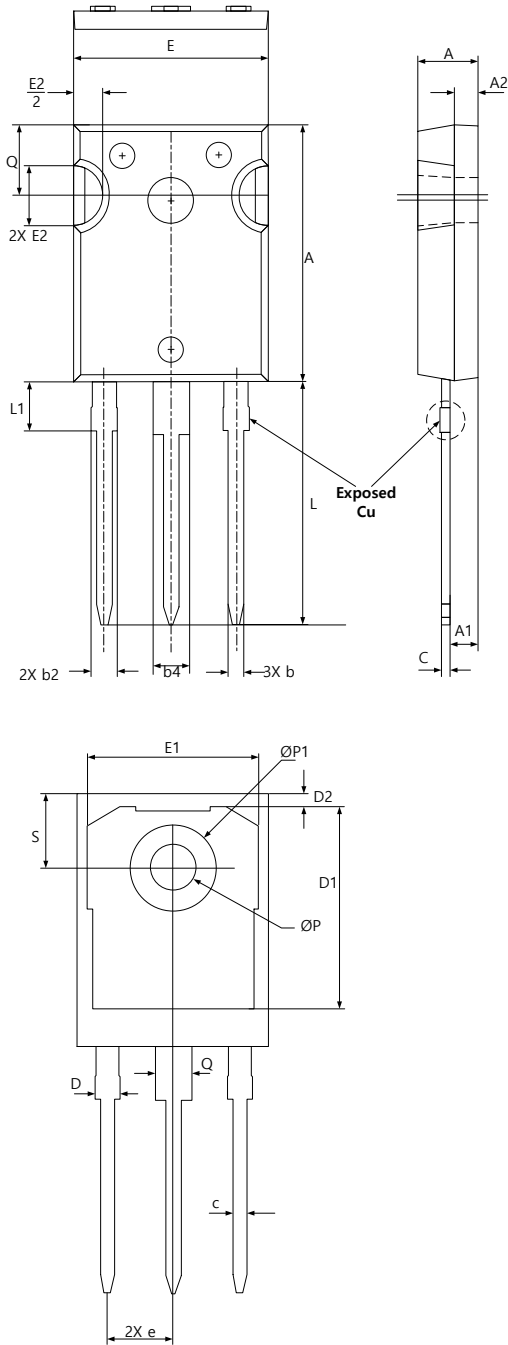

Figure 19. Transient Junction to Case Thermal Impedance

Package Outline

Unit : mm



SYMBOL	DIMENSIONS			NOTES
	MIN	NOM	MAX	
A	4.83	5.02	5.21	
A1	2.29	2.41	2.55	
A2	1.50	2.00	2.49	
b	1.12	1.20	1.33	
b1	1.12	1.20	1.28	
b2	1.91	2.00	2.39	6
b3	1.91	2.00	2.34	
b4	2.87	3.00	3.22	6, 8
b5	2.87	3.00	3.18	
c	0.55	0.60	0.69	6
c1	0.55	6.00	0.65	
D	20.80	20.95	21.10	4
D1	16.25	16.55	17.65	5
D2	0.51	1.19	1.35	
E	15.75	15.94	16.13	4
E1	13.46	14.02	14.16	5
E2	4.32	4.91	5.49	3
e	5.44 BSC			
L	19.81	20.07	20.32	
L1	4.10	4.19	4.40	6
ϕP	3.56	3.61	3.65	7
$\phi P1$	7.19 REF			
Q	5.39	5.79	6.20	
S	6.04	6.17	6.30	